



# STK600 Starter Kit

---

## STK600 AVR® Flash MCU Starter Kit User's Guide

---

### Overview

---

The STK600 is a complete starter kit and development system for the AVR® Flash microcontroller. It allows designers a quick start in developing code on the AVR device, combined with advanced features for using the starter kit to prototype and test new designs.

New firmware releases for STK600 are embedded with the releases of Atmel Studio. The upgrade process starts with a connection to the STK600 board (the user will be asked to perform the procedure). Should the automatic upgrade fail, try the [manual upgrade procedure](#).



## Table of Contents

Overview.....	1
1. Features.....	4
2. Known Issues.....	5
3. Device Support.....	6
4. Getting Started.....	44
4.1. Kit Contents.....	44
4.2. Quick Start.....	44
4.3. Connecting the Hardware.....	45
5. Target Socket System.....	46
5.1. Socket System.....	46
5.2. Socket Card and Routing Card.....	46
5.3. Selecting the Correct Routing and Socket Cards.....	48
5.4. Mounting the Cards.....	49
5.5. Signal Integrity.....	56
5.6. AVR UC3 Routing Card Pin Mapping.....	56
5.7. SAM Routing Cards.....	87
6. Hardware Description.....	88
6.1. STK600 Block Diagram.....	88
6.2. Target Voltage VTG.....	88
6.3. Analog Reference Voltages.....	89
6.4. RESET Control.....	91
6.5. Port Connectors.....	92
6.6. LEDs and Switches.....	94
6.7. Clock Settings.....	95
6.8. User RS-232 Interface.....	98
6.9. DataFlash Nonvolatile Memory.....	99
6.10. Expansion Connectors.....	99
6.11. User USB Connector.....	102
6.12. CAN Transceiver.....	103
6.13. LIN Transceiver.....	105
6.14. Miscellaneous.....	106
7. Programming.....	108
7.1. ISP Programming.....	108
7.2. Parallel High-Voltage Programming.....	109
7.3. Serial High-Voltage Programming.....	110
7.4. JTAG Programming.....	112
7.5. PDI Programming.....	113
7.6. UPDI Programming.....	115

7.7. aWire Programming.....	117
7.8. TPI Programming.....	119
7.9. In-System Programming of an External Target System.....	121
8. Command Line Utility.....	124
9. Troubleshooting and Support.....	125
9.1. Troubleshooting Guide.....	125
9.2. Routing and Socket Card Issues.....	127
9.3. Technical Support.....	128
9.4. Firmware Upgrade.....	128
10. Revision History.....	130
The Microchip Web Site.....	131
Customer Change Notification Service.....	131
Customer Support.....	131
Microchip Devices Code Protection Feature.....	131
Legal Notice.....	132
Trademarks.....	132
Quality Management System Certified by DNV.....	133
Worldwide Sales and Service.....	134

### 1. Features

- AVR Studio 4/AVR32 Studio/AVR Studio 5/Atmel Studio Compatible
- USB Interface to PC for Programming and Control
- Powered from USB Bus or from an External 10-15V DC Power Supply
- Adjustable Target  $V_{CC}$  (0-5.5V)
- Two Adjustable Reference Voltages with High Accuracy (0-5.0V, 10 mV res.)
- Clock Oscillator, Adjustable On-The-Fly from Atmel Studio (0-50 MHz, 0.1% res.)
- Serial In-System Programming (ISP) of tinyAVR<sup>®</sup> and megaAVR<sup>®</sup> Devices
- PDI Programming of AVR XMEGA<sup>®</sup> Devices
- JTAG Programming of megaAVR, AVR XMEGA, and AVR UC3 Devices
- aWire Programming of AVR UC3 Devices
- ISP and JTAG Programming of AVR Devices in External Target Systems
- Flexible Routing and Socket Card System for Easy Mounting of all Supported Devices
- Eight Push Buttons for General Use
- Eight LEDs for General Use
- All AVR I/O Ports are Easily Accessible through Pin Header Connectors
- Expansion Connectors for Plug-In Modules and Prototyping Area
- On-Board 4 Mb DataFlash for Non-volatile Data
- USB mini-AB (On-The-Go) Connector for AVR Devices with USB
- PHY and DSUB-9 Connector for RS-232 Interface
- PHY and DSUB-9 Connector for CAN Bus
- PHY and Header for LIN Bus
- Device Board with an ATmega2560 AVR Microcontroller Included

**Note:** Socket cards and routing cards must be bought separately.

## **2. Known Issues**

There are no known issues with the STK600.

### 3. Device Support

Atmel Studio, AVR Studio 4, 5, and AVR32 Studio has support for a range of devices in all speed grades. Support for new AVR devices may be added in new versions of the software. Latest versions of the Integrated Development Environments are always available from [www.microchip.com](http://www.microchip.com).

**Table 3-1. Device Support**

Device	Routing Card	Socket Card	Comment
AT32UC3A0128	ATSTK600-RC33 - STK600-RCUC3A144-33	ATSTK600-SC19 - STK600-TQFP144	
AT32UC3A0256	ATSTK600-RC33 - STK600-RCUC3A144-33	ATSTK600-SC19 - STK600-TQFP144	
AT32UC3A0512	ATSTK600-RC33 - STK600-RCUC3A144-33	ATSTK600-SC19 - STK600-TQFP144	
AT32UC3A1128	ATSTK600-RC28 - STK600-RCUC3A100-28	ATSTK600-SC03 - STK600-TQFP100	
AT32UC3A1256	ATSTK600-RC28 - STK600-RCUC3A100-28	ATSTK600-SC03 - STK600-TQFP100	
AT32UC3A1512	ATSTK600-RC28 - STK600-RCUC3A100-28	ATSTK600-SC03 - STK600-TQFP100	
AT32UC3A3128	ATSTK600-RC32 - STK600-RCUC3A144-32	ATSTK600-SC19 - STK600-TQFP144	
AT32UC3A3128S	ATSTK600-RC32 - STK600-RCUC3A144-32	ATSTK600-SC19 - STK600-TQFP144	
AT32UC3A3256	ATSTK600-RC32 - STK600-RCUC3A144-32	ATSTK600-SC19 - STK600-TQFP144	
AT32UC3A3256S	ATSTK600-RC32 - STK600-RCUC3A144-32	ATSTK600-SC19 - STK600-TQFP144	
AT32UC3A364	ATSTK600-RC32 - STK600-RCUC3A144-32	ATSTK600-SC19 - STK600-TQFP144	
AT32UC3A364S	ATSTK600-RC32 - STK600-RCUC3A144-32	ATSTK600-SC19 - STK600-TQFP144	
AT32UC3B0128	ATSTK600-RC21 - STK600-RCUC3B0-21	ATSTK600-SC14 - STK600-TQFP64-2	
AT32UC3B0128	ATSTK600-RC21 - STK600-RCUC3B0-21	ATSTK600-SC21 - STK600-QFN64	
AT32UC3B0256	ATSTK600-RC21 - STK600-RCUC3B0-21	ATSTK600-SC14 - STK600-TQFP64-2	
AT32UC3B0256	ATSTK600-RC21 - STK600-RCUC3B0-21	ATSTK600-SC21 - STK600-QFN64	

# STK600 Starter Kit

## Device Support

Device	Routing Card	Socket Card	Comment
AT32UC3B0512	ATSTK600-RC21 - STK600-RCUC3B0-21	ATSTK600-SC14 - STK600-TQFP64-2	
AT32UC3B0512	ATSTK600-RC21 - STK600-RCUC3B0-21	ATSTK600-SC21 - STK600-QFN64	
AT32UC3B064	ATSTK600-RC21 - STK600-RCUC3B0-21	ATSTK600-SC14 - STK600-TQFP64-2	
AT32UC3B064	ATSTK600-RC21 - STK600-RCUC3B0-21	ATSTK600-SC21 - STK600-QFN64	
AT32UC3B1128	ATSTK600-RC27 - STK600-RCUC3B48-27	ATSTK600-SC16 - STK600-TQFP48	
AT32UC3B1128	ATSTK600-RC27 - STK600-RCUC3B48-27	ATSTK600-SC41 - STK600-QFN48	
AT32UC3B1256	ATSTK600-RC27 - STK600-RCUC3B48-27	ATSTK600-SC16 - STK600-TQFP48	
AT32UC3B1256	ATSTK600-RC27 - STK600-RCUC3B48-27	ATSTK600-SC41 - STK600-QFN48	
AT32UC3B1512	ATSTK600-RC27 - STK600-RCUC3B48-27	ATSTK600-SC16 - STK600-TQFP48	
AT32UC3B1512	ATSTK600-RC27 - STK600-RCUC3B48-27	ATSTK600-SC41 - STK600-QFN48	
AT32UC3B164	ATSTK600-RC27 - STK600-RCUC3B48-27	ATSTK600-SC16 - STK600-TQFP48	
AT32UC3B164	ATSTK600-RC27 - STK600-RCUC3B48-27	ATSTK600-SC41 - STK600-QFN48	
AT32UC3C0128C	ATSTK600-RC36 - STK600-RCUC3C0-36	ATSTK600-SC19 - STK600-TQFP144	
AT32UC3C0256C	ATSTK600-RC36 - STK600-RCUC3C0-36	ATSTK600-SC19 - STK600-TQFP144	
AT32UC3C0512C	ATSTK600-RC36 - STK600-RCUC3C0-36	ATSTK600-SC19 - STK600-TQFP144	
AT32UC3C064C	ATSTK600-RC36 - STK600-RCUC3C0-36	ATSTK600-SC19 - STK600-TQFP144	
AT32UC3C1128C	ATSTK600-RC38 - STK600-RCUC3C1-38	ATSTK600-SC03 - STK600-TQFP100	
AT32UC3C1256C	ATSTK600-RC38 - STK600-RCUC3C1-38	ATSTK600-SC03 - STK600-TQFP100	
AT32UC3C1512C	ATSTK600-RC38 - STK600-RCUC3C1-38	ATSTK600-SC03 - STK600-TQFP100	

Device	Routing Card	Socket Card	Comment
AT32UC3C164C	ATSTK600-RC38 - STK600-RCUC3C1-38	ATSTK600-SC03 - STK600-TQFP100	
AT32UC3C2128C	ATSTK600-RC40 - STK600-RCUC3C2-40	ATSTK600-SC14 - STK600-TQFP64-2	
AT32UC3C2128C	ATSTK600-RC40 - STK600-RCUC3C2-40	ATSTK600-SC21 - STK600-QFN64	
AT32UC3C2256C	ATSTK600-RC40 - STK600-RCUC3C2-40	ATSTK600-SC14 - STK600-TQFP64-2	
AT32UC3C2256C	ATSTK600-RC40 - STK600-RCUC3C2-40	ATSTK600-SC21 - STK600-QFN64	
AT32UC3C2512C	ATSTK600-RC40 - STK600-RCUC3C2-40	ATSTK600-SC14 - STK600-TQFP64-2	
AT32UC3C2512C	ATSTK600-RC40 - STK600-RCUC3C2-40	ATSTK600-SC21 - STK600-QFN64	
AT32UC3C264C	ATSTK600-RC40 - STK600-RCUC3C2-40	ATSTK600-SC14 - STK600-TQFP64-2	
AT32UC3C264C	ATSTK600-RC40 - STK600-RCUC3C2-40	ATSTK600-SC21 - STK600-QFN64	
AT32UC3L0128	ATSTK600-RC34 - STK600-RCUC3L0-34	ATSTK600-SC16 - STK600-TQFP48	
AT32UC3L0128	ATSTK600-RC34 - STK600-RCUC3L0-34	ATSTK600-SC41 - STK600-QFN48	
AT32UC3L016	ATSTK600-RC34 - STK600-RCUC3L0-34	ATSTK600-SC16 - STK600-TQFP48	
AT32UC3L016	ATSTK600-RC34 - STK600-RCUC3L0-34	ATSTK600-SC41 - STK600-QFN48	
AT32UC3L0256	ATSTK600-RC34 - STK600-RCUC3L0-34	ATSTK600-SC16 - STK600-TQFP48	
AT32UC3L0256	ATSTK600-RC34 - STK600-RCUC3L0-34	ATSTK600-SC41 - STK600-QFN48	
AT32UC3L032	ATSTK600-RC34 - STK600-RCUC3L0-34	ATSTK600-SC16 - STK600-TQFP48	
AT32UC3L032	ATSTK600-RC34 - STK600-RCUC3L0-34	ATSTK600-SC41 - STK600-QFN48	
AT32UC3L064	ATSTK600-RC34 - STK600-RCUC3L0-34	ATSTK600-SC16 - STK600-TQFP48	
AT32UC3L064	ATSTK600-RC34 - STK600-RCUC3L0-34	ATSTK600-SC41 - STK600-QFN48	



Device	Routing Card	Socket Card	Comment
AT90CAN128	ATSTK600-RC09 - STK600-RC064M-9	ATSTK600-SC02 - STK600-TQFP64	
AT90CAN128	ATSTK600-RC09 - STK600-RC064M-9	ATSTK600-SC21 - STK600-QFN64	
AT90CAN32	ATSTK600-RC09 - STK600-RC064M-9	ATSTK600-SC02 - STK600-TQFP64	
AT90CAN32	ATSTK600-RC09 - STK600-RC064M-9	ATSTK600-SC21 - STK600-QFN64	
AT90CAN64	ATSTK600-RC09 - STK600-RC064M-9	ATSTK600-SC02 - STK600-TQFP64	
AT90CAN64	ATSTK600-RC09 - STK600-RC064M-9	ATSTK600-SC21 - STK600-QFN64	
AT90PWM1	ATSTK600-RC19 - STK600-RCPWM-19	ATSTK600-SC11 - STK600-SOIC	
AT90PWM161	ATSTK600-RC26 - STK600-RCPWM-26	ATSTK600-SC11 - STK600-SOIC	
AT90PWM216	ATSTK600-RC19 - STK600-RCPWM-19	ATSTK600-SC11 - STK600-SOIC	
AT90PWM2B	ATSTK600-RC19 - STK600-RCPWM-19	ATSTK600-SC11 - STK600-SOIC	
AT90PWM316	ATSTK600-RC19 - STK600-RCPWM-19	ATSTK600-SC11 - STK600-SOIC	
AT90PWM3B	ATSTK600-RC19 - STK600-RCPWM-19	ATSTK600-SC11 - STK600-SOIC	
AT90PWM81	ATSTK600-RC26 - STK600-RCPWM-26	ATSTK600-SC11 - STK600-SOIC	
AT90USB1286	ATSTK600-RC17 - STK600-RC064U-17	ATSTK600-SC02 - STK600-TQFP64	
AT90USB1286	ATSTK600-RC17 - STK600-RC064U-17	ATSTK600-SC21 - STK600-QFN64	
AT90USB1287	ATSTK600-RC17 - STK600-RC064U-17	ATSTK600-SC02 - STK600-TQFP64	
AT90USB1287	ATSTK600-RC17 - STK600-RC064U-17	ATSTK600-SC21 - STK600-QFN64	
AT90USB162	ATSTK600-RC20 - STK600-RC032U-20	ATSTK600-SC12 - STK600-QFN32	
AT90USB162	ATSTK600-RC20 - STK600-RC032U-20	ATSTK600-SC10 - STK600-TQFP32	

# STK600 Starter Kit

## Device Support

Device	Routing Card	Socket Card	Comment
AT90USB646	ATSTK600-RC17 - STK600-RC064U-17	ATSTK600-SC02 - STK600-TQFP64	
AT90USB646	ATSTK600-RC17 - STK600-RC064U-17	ATSTK600-SC21 - STK600-QFN64	
AT90USB647	ATSTK600-RC17 - STK600-RC064U-17	ATSTK600-SC02 - STK600-TQFP64	
AT90USB647	ATSTK600-RC17 - STK600-RC064U-17	ATSTK600-SC21 - STK600-QFN64	
AT90USB82	ATSTK600-RC20 - STK600-RC032U-20	ATSTK600-SC12 - STK600-QFN32	
AT90USB82	ATSTK600-RC20 - STK600-RC032U-20	ATSTK600-SC10 - STK600-TQFP32	
ATSAMC21E15A	ATSTK600-RC89 - STK600-RC032SAM-89	ATSTK600-SC10 - STK600-TQFP32	Breakout board only. STK600 cannot program this device
ATSAMC21E15A	ATSTK600-RC89 - STK600-RC032SAM-89	ATSTK600-SC12 - STK600-QFN32	Breakout board only. STK600 cannot program this device
ATSAMC21E16A	ATSTK600-RC89 - STK600-RC032SAM-89	ATSTK600-SC10 - STK600-TQFP32	Breakout board only. STK600 cannot program this device
ATSAMC21E16A	ATSTK600-RC89 - STK600-RC032SAM-89	ATSTK600-SC12 - STK600-QFN32	Breakout board only. STK600 cannot program this device
ATSAMC21E17A	ATSTK600-RC89 - STK600-RC032SAM-89	ATSTK600-SC10 - STK600-TQFP32	Breakout board only. STK600 cannot program this device
ATSAMC21E17A	ATSTK600-RC89 - STK600-RC032SAM-89	ATSTK600-SC12 - STK600-QFN32	Breakout board only. STK600 cannot program this device
ATSAMC21E18A	ATSTK600-RC89 - STK600-RC032SAM-89	ATSTK600-SC10 - STK600-TQFP32	Breakout board only. STK600 cannot program this device

# STK600 Starter Kit

## Device Support

Device	Routing Card	Socket Card	Comment
ATSAMC21E18A	<a href="#">ATSTK600-RC89 - STK600-RC032SAM-89</a>	<a href="#">ATSTK600-SC12 - STK600-QFN32</a>	Breakout board only. STK600 cannot program this device
ATSAMC21G15A	<a href="#">ATSTK600-RC88 - STK600-RC048SAM-88</a>	<a href="#">ATSTK600-SC16 - STK600-TQFP48</a>	Breakout board only. STK600 cannot program this device
ATSAMC21G15A	<a href="#">ATSTK600-RC88 - STK600-RC048SAM-88</a>	<a href="#">ATSTK600-SC41 - STK600-QFN48</a>	Breakout board only. STK600 cannot program this device
ATSAMC21G16A	<a href="#">ATSTK600-RC88 - STK600-RC048SAM-88</a>	<a href="#">ATSTK600-SC16 - STK600-TQFP48</a>	Breakout board only. STK600 cannot program this device
ATSAMC21G16A	<a href="#">ATSTK600-RC88 - STK600-RC048SAM-88</a>	<a href="#">ATSTK600-SC41 - STK600-QFN48</a>	Breakout board only. STK600 cannot program this device
ATSAMC21G17A	<a href="#">ATSTK600-RC88 - STK600-RC048SAM-88</a>	<a href="#">ATSTK600-SC16 - STK600-TQFP48</a>	Breakout board only. STK600 cannot program this device
ATSAMC21G17A	<a href="#">ATSTK600-RC88 - STK600-RC048SAM-88</a>	<a href="#">ATSTK600-SC41 - STK600-QFN48</a>	Breakout board only. STK600 cannot program this device
ATSAMC21G18A	<a href="#">ATSTK600-RC88 - STK600-RC048SAM-88</a>	<a href="#">ATSTK600-SC16 - STK600-TQFP48</a>	Breakout board only. STK600 cannot program this device
ATSAMC21G18A	<a href="#">ATSTK600-RC88 - STK600-RC048SAM-88</a>	<a href="#">ATSTK600-SC41 - STK600-QFN48</a>	Breakout board only. STK600 cannot program this device
ATSAMC21J15A	<a href="#">ATSTK600-RC87 - STK600-RC064SAM-87</a>	<a href="#">ATSTK600-SC14 - STK600-TQFP64-2</a>	Breakout board only. STK600 cannot program this device

# STK600 Starter Kit

## Device Support

Device	Routing Card	Socket Card	Comment
ATSAMC21J15A	<a href="#">ATSTK600-RC87 - STK600-RC064SAM-87</a>	<a href="#">ATSTK600-SC21 - STK600-QFN64</a>	Breakout board only. STK600 cannot program this device
ATSAMC21J16A	<a href="#">ATSTK600-RC87 - STK600-RC064SAM-87</a>	<a href="#">ATSTK600-SC14 - STK600-TQFP64-2</a>	Breakout board only. STK600 cannot program this device
ATSAMC21J16A	<a href="#">ATSTK600-RC87 - STK600-RC064SAM-87</a>	<a href="#">ATSTK600-SC21 - STK600-QFN64</a>	Breakout board only. STK600 cannot program this device
ATSAMC21J17A	<a href="#">ATSTK600-RC87 - STK600-RC064SAM-87</a>	<a href="#">ATSTK600-SC14 - STK600-TQFP64-2</a>	Breakout board only. STK600 cannot program this device
ATSAMC21J17A	<a href="#">ATSTK600-RC87 - STK600-RC064SAM-87</a>	<a href="#">ATSTK600-SC21 - STK600-QFN64</a>	Breakout board only. STK600 cannot program this device
ATSAMC21J17A U	<a href="#">ATSTK600-RC87 - STK600-RC064SAM-87</a>	<a href="#">ATSTK600-SC14 - STK600-TQFP64-2</a>	Breakout board only. STK600 cannot program this device
ATSAMC21J17A U	<a href="#">ATSTK600-RC87 - STK600-RC064SAM-87</a>	<a href="#">ATSTK600-SC21 - STK600-QFN64</a>	Breakout board only. STK600 cannot program this device
ATSAMC21J18A	<a href="#">ATSTK600-RC87 - STK600-RC064SAM-87</a>	<a href="#">ATSTK600-SC14 - STK600-TQFP64-2</a>	Breakout board only. STK600 cannot program this device
ATSAMC21J18A	<a href="#">ATSTK600-RC87 - STK600-RC064SAM-87</a>	<a href="#">ATSTK600-SC21 - STK600-QFN64</a>	Breakout board only. STK600 cannot program this device
ATSAMC21J18A U	<a href="#">ATSTK600-RC87 - STK600-RC064SAM-87</a>	<a href="#">ATSTK600-SC14 - STK600-TQFP64-2</a>	Breakout board only. STK600 cannot program this device

# STK600 Starter Kit

## Device Support

Device	Routing Card	Socket Card	Comment
ATSAMC21J18AU	<a href="#">ATSTK600-RC87 - STK600-RC064SAM-87</a>	<a href="#">ATSTK600-SC21 - STK600-QFN64</a>	Breakout board only. STK600 cannot program this device
ATSAMC21N17A	<a href="#">ATSTK600-RC105 - STK600-RC100SAM-105</a>	<a href="#">ATSTK600-SC03 - STK600-TQFP100</a>	Breakout board only. STK600 cannot program this device
ATSAMC21N18A	<a href="#">ATSTK600-RC105 - STK600-RC100SAM-105</a>	<a href="#">ATSTK600-SC03 - STK600-TQFP100</a>	Breakout board only. STK600 cannot program this device
ATSAMD09D14A	<a href="#">ATSTK600-RC90 - STK600-RC024SAM-90</a>	<a href="#">ATSTK600-SC62 - STK600-QFN24</a>	Breakout board only. STK600 cannot program this device.
ATSAMD10D13AM	<a href="#">ATSTK600-RC90 - STK600-RC024SAM-90</a>	<a href="#">ATSTK600-SC62 - STK600-QFN24</a>	Breakout board only. STK600 cannot program this device.
ATSAMD10D14AM	<a href="#">ATSTK600-RC90 - STK600-RC024SAM-90</a>	<a href="#">ATSTK600-SC62 - STK600-QFN24</a>	Breakout board only. STK600 cannot program this device.
ATSAMD11D14AM	<a href="#">ATSTK600-RC90 - STK600-RC024SAM-90</a>	<a href="#">ATSTK600-SC62 - STK600-QFN24</a>	Breakout board only. STK600 cannot program this device
ATSAMD20E14	<a href="#">ATSTK600-RC79 - STK600-RC032SAM-79</a>	<a href="#">ATSTK600-SC12 - STK600-QFN32</a>	Breakout board only. STK600 cannot program this device.
ATSAMD20E14	<a href="#">ATSTK600-RC79 - STK600-RC032SAM-79</a>	<a href="#">ATSTK600-SC10 - STK600-TQFP32</a>	Breakout board only. STK600 cannot program this device.
ATSAMD20E14B	<a href="#">ATSTK600-RC79 - STK600-RC032SAM-79</a>	<a href="#">ATSTK600-SC12 - STK600-QFN32</a>	Breakout board only. STK600 cannot program this device.

# STK600 Starter Kit

## Device Support

Device	Routing Card	Socket Card	Comment
ATSAMD20E14B	<a href="#">ATSTK600-RC79 - STK600-RC032SAM-79</a>	<a href="#">ATSTK600-SC10 - STK600-TQFP32</a>	Breakout board only. STK600 cannot program this device.
ATSAMD20E15	<a href="#">ATSTK600-RC79 - STK600-RC032SAM-79</a>	<a href="#">ATSTK600-SC12 - STK600-QFN32</a>	Breakout board only. STK600 cannot program this device.
ATSAMD20E15	<a href="#">ATSTK600-RC79 - STK600-RC032SAM-79</a>	<a href="#">ATSTK600-SC10 - STK600-TQFP32</a>	Breakout board only. STK600 cannot program this device.
ATSAMD20E15B	<a href="#">ATSTK600-RC79 - STK600-RC032SAM-79</a>	<a href="#">ATSTK600-SC12 - STK600-QFN32</a>	Breakout board only. STK600 cannot program this device.
ATSAMD20E15B	<a href="#">ATSTK600-RC79 - STK600-RC032SAM-79</a>	<a href="#">ATSTK600-SC10 - STK600-TQFP32</a>	Breakout board only. STK600 cannot program this device.
ATSAMD20E16	<a href="#">ATSTK600-RC79 - STK600-RC032SAM-79</a>	<a href="#">ATSTK600-SC12 - STK600-QFN32</a>	Breakout board only. STK600 cannot program this device.
ATSAMD20E16	<a href="#">ATSTK600-RC79 - STK600-RC032SAM-79</a>	<a href="#">ATSTK600-SC10 - STK600-TQFP32</a>	Breakout board only. STK600 cannot program this device.
ATSAMD20E16B	<a href="#">ATSTK600-RC79 - STK600-RC032SAM-79</a>	<a href="#">ATSTK600-SC12 - STK600-QFN32</a>	Breakout board only. STK600 cannot program this device.
ATSAMD20E16B	<a href="#">ATSTK600-RC79 - STK600-RC032SAM-79</a>	<a href="#">ATSTK600-SC10 - STK600-TQFP32</a>	Breakout board only. STK600 cannot program this device.
ATSAMD20E17	<a href="#">ATSTK600-RC79 - STK600-RC032SAM-79</a>	<a href="#">ATSTK600-SC12 - STK600-QFN32</a>	Breakout board only. STK600 cannot program this device.

# STK600 Starter Kit

## Device Support

Device	Routing Card	Socket Card	Comment
ATSAMD20E17	<a href="#">ATSTK600-RC79 - STK600-RC032SAM-79</a>	<a href="#">ATSTK600-SC10 - STK600-TQFP32</a>	Breakout board only. STK600 cannot program this device.
ATSAMD20E18	<a href="#">ATSTK600-RC79 - STK600-RC032SAM-79</a>	<a href="#">ATSTK600-SC12 - STK600-QFN32</a>	Breakout board only. STK600 cannot program this device.
ATSAMD20E18	<a href="#">ATSTK600-RC79 - STK600-RC032SAM-79</a>	<a href="#">ATSTK600-SC10 - STK600-TQFP32</a>	Breakout board only. STK600 cannot program this device.
ATSAMD20G14	<a href="#">ATSTK600-RC78 - STK600-RC048SAM-78</a>	<a href="#">ATSTK600-SC16 - STK600-TQFP48</a>	Breakout board only. STK600 cannot program this device.
ATSAMD20G14	<a href="#">ATSTK600-RC78 - STK600-RC048SAM-78</a>	<a href="#">ATSTK600-SC41 - STK600-QFN48</a>	Breakout board only. STK600 cannot program this device.
ATSAMD20G14B	<a href="#">ATSTK600-RC78 - STK600-RC048SAM-78</a>	<a href="#">ATSTK600-SC16 - STK600-TQFP48</a>	Breakout board only. STK600 cannot program this device.
ATSAMD20G14B	<a href="#">ATSTK600-RC78 - STK600-RC048SAM-78</a>	<a href="#">ATSTK600-SC41 - STK600-QFN48</a>	Breakout board only. STK600 cannot program this device.
ATSAMD20G15	<a href="#">ATSTK600-RC78 - STK600-RC048SAM-78</a>	<a href="#">ATSTK600-SC16 - STK600-TQFP48</a>	Breakout board only. STK600 cannot program this device.
ATSAMD20G15	<a href="#">ATSTK600-RC78 - STK600-RC048SAM-78</a>	<a href="#">ATSTK600-SC41 - STK600-QFN48</a>	Breakout board only. STK600 cannot program this device.
ATSAMD20G15B	<a href="#">ATSTK600-RC78 - STK600-RC048SAM-78</a>	<a href="#">ATSTK600-SC16 - STK600-TQFP48</a>	Breakout board only. STK600 cannot program this device.

# STK600 Starter Kit

## Device Support

Device	Routing Card	Socket Card	Comment
ATSAMD20G15B	<a href="#">ATSTK600-RC78 - STK600-RC048SAM-78</a>	<a href="#">ATSTK600-SC41 - STK600-QFN48</a>	Breakout board only. STK600 cannot program this device.
ATSAMD20G16	<a href="#">ATSTK600-RC78 - STK600-RC048SAM-78</a>	<a href="#">ATSTK600-SC16 - STK600-TQFP48</a>	Breakout board only. STK600 cannot program this device.
ATSAMD20G16	<a href="#">ATSTK600-RC78 - STK600-RC048SAM-78</a>	<a href="#">ATSTK600-SC41 - STK600-QFN48</a>	Breakout board only. STK600 cannot program this device.
ATSAMD20G16B	<a href="#">ATSTK600-RC78 - STK600-RC048SAM-78</a>	<a href="#">ATSTK600-SC16 - STK600-TQFP48</a>	Breakout board only. STK600 cannot program this device.
ATSAMD20G16B	<a href="#">ATSTK600-RC78 - STK600-RC048SAM-78</a>	<a href="#">ATSTK600-SC41 - STK600-QFN48</a>	Breakout board only. STK600 cannot program this device.
ATSAMD20G17	<a href="#">ATSTK600-RC78 - STK600-RC048SAM-78</a>	<a href="#">ATSTK600-SC16 - STK600-TQFP48</a>	Breakout board only. STK600 cannot program this device.
ATSAMD20G17	<a href="#">ATSTK600-RC78 - STK600-RC048SAM-78</a>	<a href="#">ATSTK600-SC41 - STK600-QFN48</a>	Breakout board only. STK600 cannot program this device.
ATSAMD20G18	<a href="#">ATSTK600-RC78 - STK600-RC048SAM-78</a>	<a href="#">ATSTK600-SC16 - STK600-TQFP48</a>	Breakout board only. STK600 cannot program this device.
ATSAMD20G18	<a href="#">ATSTK600-RC78 - STK600-RC048SAM-78</a>	<a href="#">ATSTK600-SC41 - STK600-QFN48</a>	Breakout board only. STK600 cannot program this device.
ATSAMD20J14	<a href="#">ATSTK600-RC72 - STK600-RC064SAM-72</a>	<a href="#">ATSTK600-SC14 - STK600-TQFP64-2</a>	Breakout board only. STK600 cannot program this device.



# STK600 Starter Kit

## Device Support

Device	Routing Card	Socket Card	Comment
ATSAMD20J14	<a href="#">ATSTK600-RC72 - STK600-RC064SAM-72</a>	<a href="#">ATSTK600-SC21 - STK600-QFN64</a>	Breakout board only. STK600 cannot program this device.
ATSAMD20J14B	<a href="#">ATSTK600-RC72 - STK600-RC064SAM-72</a>	<a href="#">ATSTK600-SC14 - STK600-TQFP64-2</a>	Breakout board only. STK600 cannot program this device.
ATSAMD20J14B	<a href="#">ATSTK600-RC72 - STK600-RC064SAM-72</a>	<a href="#">ATSTK600-SC21 - STK600-QFN64</a>	Breakout board only. STK600 cannot program this device.
ATSAMD20J15	<a href="#">ATSTK600-RC72 - STK600-RC064SAM-72</a>	<a href="#">ATSTK600-SC14 - STK600-TQFP64-2</a>	Breakout board only. STK600 cannot program this device.
ATSAMD20J15	<a href="#">ATSTK600-RC72 - STK600-RC064SAM-72</a>	<a href="#">ATSTK600-SC21 - STK600-QFN64</a>	Breakout board only. STK600 cannot program this device.
ATSAMD20J15B	<a href="#">ATSTK600-RC72 - STK600-RC064SAM-72</a>	<a href="#">ATSTK600-SC14 - STK600-TQFP64-2</a>	Breakout board only. STK600 cannot program this device.
ATSAMD20J15B	<a href="#">ATSTK600-RC72 - STK600-RC064SAM-72</a>	<a href="#">ATSTK600-SC21 - STK600-QFN64</a>	Breakout board only. STK600 cannot program this device.
ATSAMD20J16	<a href="#">ATSTK600-RC72 - STK600-RC064SAM-72</a>	<a href="#">ATSTK600-SC14 - STK600-TQFP64-2</a>	Breakout board only. STK600 cannot program this device.
ATSAMD20J16	<a href="#">ATSTK600-RC72 - STK600-RC064SAM-72</a>	<a href="#">ATSTK600-SC21 - STK600-QFN64</a>	Breakout board only. STK600 cannot program this device.
ATSAMD20J16B	<a href="#">ATSTK600-RC72 - STK600-RC064SAM-72</a>	<a href="#">ATSTK600-SC14 - STK600-TQFP64-2</a>	Breakout board only. STK600 cannot program this device.

# STK600 Starter Kit

## Device Support

Device	Routing Card	Socket Card	Comment
ATSAMD20J16B	<a href="#">ATSTK600-RC72 - STK600-RC064SAM-72</a>	<a href="#">ATSTK600-SC21 - STK600-QFN64</a>	Breakout board only. STK600 cannot program this device.
ATSAMD20J17	<a href="#">ATSTK600-RC72 - STK600-RC064SAM-72</a>	<a href="#">ATSTK600-SC14 - STK600-TQFP64-2</a>	Breakout board only. STK600 cannot program this device.
ATSAMD20J17	<a href="#">ATSTK600-RC72 - STK600-RC064SAM-72</a>	<a href="#">ATSTK600-SC21 - STK600-QFN64</a>	Breakout board only. STK600 cannot program this device.
ATSAMD20J18	<a href="#">ATSTK600-RC72 - STK600-RC064SAM-72</a>	<a href="#">ATSTK600-SC14 - STK600-TQFP64-2</a>	Breakout board only. STK600 cannot program this device.
ATSAMD20J18	<a href="#">ATSTK600-RC72 - STK600-RC064SAM-72</a>	<a href="#">ATSTK600-SC21 - STK600-QFN64</a>	Breakout board only. STK600 cannot program this device.
ATSAMD21E15A	<a href="#">ATSTK600-RC89 - STK600-RC032SAM-89</a>	<a href="#">ATSTK600-SC10 - STK600-TQFP32</a>	Breakout board only. STK600 cannot program this device.
ATSAMD21E15A	<a href="#">ATSTK600-RC89 - STK600-RC032SAM-89</a>	<a href="#">ATSTK600-SC12 - STK600-QFN32</a>	Breakout board only. STK600 cannot program this device.
ATSAMD21E15B	<a href="#">ATSTK600-RC89 - STK600-RC032SAM-89</a>	<a href="#">ATSTK600-SC10 - STK600-TQFP32</a>	Breakout board only. STK600 cannot program this device.
ATSAMD21E15B	<a href="#">ATSTK600-RC89 - STK600-RC032SAM-89</a>	<a href="#">ATSTK600-SC12 - STK600-QFN32</a>	Breakout board only. STK600 cannot program this device.
ATSAMD21E16A	<a href="#">ATSTK600-RC89 - STK600-RC032SAM-89</a>	<a href="#">ATSTK600-SC10 - STK600-TQFP32</a>	Breakout board only. STK600 cannot program this device.

# STK600 Starter Kit

## Device Support

Device	Routing Card	Socket Card	Comment
ATSAMD21E16A	<a href="#">ATSTK600-RC89 - STK600-RC032SAM-89</a>	<a href="#">ATSTK600-SC12 - STK600-QFN32</a>	Breakout board only. STK600 cannot program this device.
ATSAMD21E16B	<a href="#">ATSTK600-RC89 - STK600-RC032SAM-89</a>	<a href="#">ATSTK600-SC10 - STK600-TQFP32</a>	Breakout board only. STK600 cannot program this device.
ATSAMD21E16B	<a href="#">ATSTK600-RC89 - STK600-RC032SAM-89</a>	<a href="#">ATSTK600-SC12 - STK600-QFN32</a>	Breakout board only. STK600 cannot program this device.
ATSAMD21E17A	<a href="#">ATSTK600-RC89 - STK600-RC032SAM-89</a>	<a href="#">ATSTK600-SC10 - STK600-TQFP32</a>	Breakout board only. STK600 cannot program this device.
ATSAMD21E17A	<a href="#">ATSTK600-RC89 - STK600-RC032SAM-89</a>	<a href="#">ATSTK600-SC12 - STK600-QFN32</a>	Breakout board only. STK600 cannot program this device.
ATSAMD21E18A	<a href="#">ATSTK600-RC89 - STK600-RC032SAM-89</a>	<a href="#">ATSTK600-SC10 - STK600-TQFP32</a>	Breakout board only. STK600 cannot program this device.
ATSAMD21E18A	<a href="#">ATSTK600-RC89 - STK600-RC032SAM-89</a>	<a href="#">ATSTK600-SC12 - STK600-QFN32</a>	Breakout board only. STK600 cannot program this device.
ATSAMD21G15A	<a href="#">ATSTK600-RC88 - STK600-RC048SAM-88</a>	<a href="#">ATSTK600-SC16 - STK600-TQFP48</a>	Breakout board only. STK600 cannot program this device.
ATSAMD21G15A	<a href="#">ATSTK600-RC88 - STK600-RC048SAM-88</a>	<a href="#">ATSTK600-SC41 - STK600-QFN48</a>	Breakout board only. STK600 cannot program this device.
ATSAMD21G15B	<a href="#">ATSTK600-RC88 - STK600-RC048SAM-88</a>	<a href="#">ATSTK600-SC16 - STK600-TQFP48</a>	Breakout board only. STK600 cannot program this device.

# STK600 Starter Kit

## Device Support

Device	Routing Card	Socket Card	Comment
ATSAMD21G15B	<a href="#">ATSTK600-RC88 - STK600-RC048SAM-88</a>	<a href="#">ATSTK600-SC41 - STK600-QFN48</a>	Breakout board only. STK600 cannot program this device.
ATSAMD21G16A	<a href="#">ATSTK600-RC88 - STK600-RC048SAM-88</a>	<a href="#">ATSTK600-SC16 - STK600-TQFP48</a>	Breakout board only. STK600 cannot program this device.
ATSAMD21G16A	<a href="#">ATSTK600-RC88 - STK600-RC048SAM-88</a>	<a href="#">ATSTK600-SC41 - STK600-QFN48</a>	Breakout board only. STK600 cannot program this device.
ATSAMD21G16B	<a href="#">ATSTK600-RC88 - STK600-RC048SAM-88</a>	<a href="#">ATSTK600-SC16 - STK600-TQFP48</a>	Breakout board only. STK600 cannot program this device.
ATSAMD21G16B	<a href="#">ATSTK600-RC88 - STK600-RC048SAM-88</a>	<a href="#">ATSTK600-SC41 - STK600-QFN48</a>	Breakout board only. STK600 cannot program this device.
ATSAMD21G17A	<a href="#">ATSTK600-RC88 - STK600-RC048SAM-88</a>	<a href="#">ATSTK600-SC16 - STK600-TQFP48</a>	Breakout board only. STK600 cannot program this device.
ATSAMD21G17A	<a href="#">ATSTK600-RC88 - STK600-RC048SAM-88</a>	<a href="#">ATSTK600-SC41 - STK600-QFN48</a>	Breakout board only. STK600 cannot program this device.
ATSAMD21G18A	<a href="#">ATSTK600-RC88 - STK600-RC048SAM-88</a>	<a href="#">ATSTK600-SC16 - STK600-TQFP48</a>	Breakout board only. STK600 cannot program this device.
ATSAMD21G18A	<a href="#">ATSTK600-RC88 - STK600-RC048SAM-88</a>	<a href="#">ATSTK600-SC41 - STK600-QFN48</a>	Breakout board only. STK600 cannot program this device.
ATSAMD21J15A	<a href="#">ATSTK600-RC87 - STK600-RC064SAM-87</a>	<a href="#">ATSTK600-SC14 - STK600-TQFP64-2</a>	Breakout board only. STK600 cannot program this device.

# STK600 Starter Kit

## Device Support

Device	Routing Card	Socket Card	Comment
ATSAMD21J15A	<a href="#">ATSTK600-RC87 - STK600-RC064SAM-87</a>	<a href="#">ATSTK600-SC21 - STK600-QFN64</a>	Breakout board only. STK600 cannot program this device.
ATSAMD21J15B	<a href="#">ATSTK600-RC87 - STK600-RC064SAM-87</a>	<a href="#">ATSTK600-SC14 - STK600-TQFP64-2</a>	Breakout board only. STK600 cannot program this device.
ATSAMD21J15B	<a href="#">ATSTK600-RC87 - STK600-RC064SAM-87</a>	<a href="#">ATSTK600-SC21 - STK600-QFN64</a>	Breakout board only. STK600 cannot program this device.
ATSAMD21J16A	<a href="#">ATSTK600-RC87 - STK600-RC064SAM-87</a>	<a href="#">ATSTK600-SC14 - STK600-TQFP64-2</a>	Breakout board only. STK600 cannot program this device.
ATSAMD21J16A	<a href="#">ATSTK600-RC87 - STK600-RC064SAM-87</a>	<a href="#">ATSTK600-SC21 - STK600-QFN64</a>	Breakout board only. STK600 cannot program this device.
ATSAMD21J16B	<a href="#">ATSTK600-RC87 - STK600-RC064SAM-87</a>	<a href="#">ATSTK600-SC14 - STK600-TQFP64-2</a>	Breakout board only. STK600 cannot program this device.
ATSAMD21J16B	<a href="#">ATSTK600-RC87 - STK600-RC064SAM-87</a>	<a href="#">ATSTK600-SC21 - STK600-QFN64</a>	Breakout board only. STK600 cannot program this device.
ATSAMD21J17A	<a href="#">ATSTK600-RC87 - STK600-RC064SAM-87</a>	<a href="#">ATSTK600-SC14 - STK600-TQFP64-2</a>	Breakout board only. STK600 cannot program this device.
ATSAMD21J17A	<a href="#">ATSTK600-RC87 - STK600-RC064SAM-87</a>	<a href="#">ATSTK600-SC21 - STK600-QFN64</a>	Breakout board only. STK600 cannot program this device.
ATSAMD21J18A	<a href="#">ATSTK600-RC87 - STK600-RC064SAM-87</a>	<a href="#">ATSTK600-SC14 - STK600-TQFP64-2</a>	Breakout board only. STK600 cannot program this device.

Device	Routing Card	Socket Card	Comment
ATSAMD21J18A	ATSTK600-RC87 - STK600-RC064SAM-87	ATSTK600-SC21 - STK600-QFN64	Breakout board only. STK600 cannot program this device.
ATUC128D3	ATSTK600-RC48 - STK600-RCUC3D3-48	ATSTK600-SC14 - STK600-TQFP64-2	
ATUC128D3	ATSTK600-RC48 - STK600-RCUC3D3-48	ATSTK600-SC21 - STK600-QFN64	
ATUC128D4	ATSTK600-RC49 - STK600-RCUC3D4-49	ATSTK600-SC41 - STK600-QFN48	
ATUC128D4	ATSTK600-RC49 - STK600-RCUC3D4-49	ATSTK600-SC16 - STK600-TQFP48	
ATUC128L3U	ATSTK600-RC47 - STK600-RCUC3L3U-47	ATSTK600-SC14 - STK600-TQFP64-2	
ATUC128L3U	ATSTK600-RC47 - STK600-RCUC3L3U-47	ATSTK600-SC21 - STK600-QFN64	
ATUC128L4U	ATSTK600-RC53 - STK600-RCUC3L4U-53	ATSTK600-SC41 - STK600-QFN48	
ATUC128L4U	ATSTK600-RC53 - STK600-RCUC3L4U-53	ATSTK600-SC16 - STK600-TQFP48	
ATUC256L3U	ATSTK600-RC47 - STK600-RCUC3L3U-47	ATSTK600-SC14 - STK600-TQFP64-2	
ATUC256L3U	ATSTK600-RC47 - STK600-RCUC3L3U-47	ATSTK600-SC21 - STK600-QFN64	
ATUC256L4U	ATSTK600-RC53 - STK600-RCUC3L4U-53	ATSTK600-SC41 - STK600-QFN48	
ATUC256L4U	ATSTK600-RC53 - STK600-RCUC3L4U-53	ATSTK600-SC16 - STK600-TQFP48	
ATUC64D3	ATSTK600-RC48 - STK600-RCUC3D3-48	ATSTK600-SC14 - STK600-TQFP64-2	
ATUC64D3	ATSTK600-RC48 - STK600-RCUC3D3-48	ATSTK600-SC21 - STK600-QFN64	
ATUC64D4	ATSTK600-RC49 - STK600-RCUC3D4-49	ATSTK600-SC41 - STK600-QFN48	
ATUC64D4	ATSTK600-RC49 - STK600-RCUC3D4-49	ATSTK600-SC16 - STK600-TQFP48	
ATUC64L3U	ATSTK600-RC47 - STK600-RCUC3L3U-47	ATSTK600-SC14 - STK600-TQFP64-2	

# STK600 Starter Kit

## Device Support

Device	Routing Card	Socket Card	Comment
ATUC64L3U	ATSTK600-RC47 - STK600-RCUC3L3U-47	ATSTK600-SC21 - STK600-QFN64	
ATUC64L4U	ATSTK600-RC53 - STK600-RCUC3L4U-53	ATSTK600-SC41 - STK600-QFN48	
ATUC64L4U	ATSTK600-RC53 - STK600-RCUC3L4U-53	ATSTK600-SC16 - STK600-TQFP48	
ATmega128	ATSTK600-RC09 - STK600-RC064M-9	ATSTK600-SC02 - STK600-TQFP64	
ATmega128	ATSTK600-RC09 - STK600-RC064M-9	ATSTK600-SC21 - STK600-QFN64	
ATmega1280	ATSTK600-RC11 - STK600-RC100M-11	ATSTK600-SC03 - STK600-TQFP100	
ATmega1281	ATSTK600-RC09 - STK600-RC064M-9	ATSTK600-SC02 - STK600-TQFP64	
ATmega1281	ATSTK600-RC09 - STK600-RC064M-9	ATSTK600-SC21 - STK600-QFN64	
ATmega1284	ATSTK600-RC05 - STK600-RC040M-5	ATSTK600-SC01 - STK600-DIP	
ATmega1284	ATSTK600-RC31 - STK600-RC044M-31	ATSTK600-SC06 - STK600-TQFP44	
ATmega1284	ATSTK600-RC31 - STK600-RC044M-31	ATSTK600-SC45 - STK600-QFN44	
ATmega1284P	ATSTK600-RC05 - STK600-RC040M-5	ATSTK600-SC01 - STK600-DIP	
ATmega1284P	ATSTK600-RC31 - STK600-RC044M-31	ATSTK600-SC06 - STK600-TQFP44	
ATmega1284P	ATSTK600-RC31 - STK600-RC044M-31	ATSTK600-SC45 - STK600-QFN44	
ATmega128A	ATSTK600-RC09 - STK600-RC064M-9	ATSTK600-SC02 - STK600-TQFP64	
ATmega128A	ATSTK600-RC09 - STK600-RC064M-9	ATSTK600-SC21 - STK600-QFN64	
ATmega128RFA1		ATAVR128RFA1-EK1 - STK600-ATMEGA128RFA1	
ATmega16	ATSTK600-RC05 - STK600-RC040M-5	ATSTK600-SC01 - STK600-DIP	
ATmega16	ATSTK600-RC31 - STK600-RC044M-31	ATSTK600-SC06 - STK600-TQFP44	

Device	Routing Card	Socket Card	Comment
ATmega16	ATSTK600-RC31 - STK600-RC044M-31	ATSTK600-SC45 - STK600-QFN44	
ATmega1609	ATSTK600-RC107 - STK600-RC048M-107	ATSTK600-SC41 - STK600-QFN48	
ATmega1609	ATSTK600-RC107 - STK600-RC048M-107	ATSTK600-SC16 - STK600-TQFP48	
ATmega162	ATSTK600-RC30 - STK600-RC044M-30	ATSTK600-SC06 - STK600-TQFP44	
ATmega162	ATSTK600-RC04 - STK600-RC040M-4	ATSTK600-SC01 - STK600-DIP	
ATmega162	ATSTK600-RC30 - STK600-RC044M-30	ATSTK600-SC45 - STK600-QFN44	
ATmega164A	ATSTK600-RC05 - STK600-RC040M-5	ATSTK600-SC01 - STK600-DIP	
ATmega164A	ATSTK600-RC31 - STK600-RC044M-31	ATSTK600-SC06 - STK600-TQFP44	
ATmega164A	ATSTK600-RC31 - STK600-RC044M-31	ATSTK600-SC45 - STK600-QFN44	
ATmega164P	ATSTK600-RC05 - STK600-RC040M-5	ATSTK600-SC01 - STK600-DIP	
ATmega164P	ATSTK600-RC31 - STK600-RC044M-31	ATSTK600-SC06 - STK600-TQFP44	
ATmega164P	ATSTK600-RC31 - STK600-RC044M-31	ATSTK600-SC45 - STK600-QFN44	
ATmega164PA	ATSTK600-RC05 - STK600-RC040M-5	ATSTK600-SC01 - STK600-DIP	
ATmega164PA	ATSTK600-RC31 - STK600-RC044M-31	ATSTK600-SC06 - STK600-TQFP44	
ATmega164PA	ATSTK600-RC31 - STK600-RC044M-31	ATSTK600-SC45 - STK600-QFN44	
ATmega165A	ATSTK600-RC10 - STK600-RC064M-10	ATSTK600-SC02 - STK600-TQFP64	
ATmega165A	ATSTK600-RC10 - STK600-RC064M-10	ATSTK600-SC21 - STK600-QFN64	
ATmega165P	ATSTK600-RC10 - STK600-RC064M-10	ATSTK600-SC02 - STK600-TQFP64	
ATmega165P	ATSTK600-RC10 - STK600-RC064M-10	ATSTK600-SC21 - STK600-QFN64	



Device	Routing Card	Socket Card	Comment
ATmega165PA	ATSTK600-RC10 - STK600-RC064M-10	ATSTK600-SC02 - STK600-TQFP64	
ATmega165PA	ATSTK600-RC10 - STK600-RC064M-10	ATSTK600-SC21 - STK600-QFN64	
ATmega168	ATSTK600-RC29 - STK600-RC032M-29	ATSTK600-SC10 - STK600-TQFP32	
ATmega168	ATSTK600-RC29 - STK600-RC032M-29	ATSTK600-SC12 - STK600-QFN32	
ATmega168	ATSTK600-RC06 - STK600-RC028M-6	ATSTK600-SC01 - STK600-DIP	
ATmega168A	ATSTK600-RC29 - STK600-RC032M-29	ATSTK600-SC10 - STK600-TQFP32	
ATmega168A	ATSTK600-RC29 - STK600-RC032M-29	ATSTK600-SC12 - STK600-QFN32	
ATmega168A	ATSTK600-RC06 - STK600-RC028M-6	ATSTK600-SC01 - STK600-DIP	
ATmega168P	ATSTK600-RC29 - STK600-RC032M-29	ATSTK600-SC10 - STK600-TQFP32	
ATmega168P	ATSTK600-RC29 - STK600-RC032M-29	ATSTK600-SC12 - STK600-QFN32	
ATmega168P	ATSTK600-RC06 - STK600-RC028M-6	ATSTK600-SC01 - STK600-DIP	
ATmega168PA	ATSTK600-RC29 - STK600-RC032M-29	ATSTK600-SC10 - STK600-TQFP32	
ATmega168PA	ATSTK600-RC29 - STK600-RC032M-29	ATSTK600-SC12 - STK600-QFN32	
ATmega168PA	ATSTK600-RC06 - STK600-RC028M-6	ATSTK600-SC01 - STK600-DIP	
ATmega168PB	ATSTK600-RC91 - STK600-RC032M-91	ATSTK600-SC10 - STK600-TQFP32	
ATmega168PB	ATSTK600-RC91 - STK600-RC032M-91	ATSTK600-SC12 - STK600-QFN32	
ATmega169A	ATSTK600-RC10 - STK600-RC064M-10	ATSTK600-SC02 - STK600-TQFP64	
ATmega169A	ATSTK600-RC10 - STK600-RC064M-10	ATSTK600-SC21 - STK600-QFN64	
ATmega169P	ATSTK600-RC10 - STK600-RC064M-10	ATSTK600-SC02 - STK600-TQFP64	

Device	Routing Card	Socket Card	Comment
ATmega169P	ATSTK600-RC10 - STK600-RC064M-10	ATSTK600-SC21 - STK600-QFN64	
ATmega169PA	ATSTK600-RC10 - STK600-RC064M-10	ATSTK600-SC02 - STK600-TQFP64	
ATmega169PA	ATSTK600-RC10 - STK600-RC064M-10	ATSTK600-SC21 - STK600-QFN64	
ATmega16A	ATSTK600-RC05 - STK600-RC040M-5	ATSTK600-SC01 - STK600-DIP	
ATmega16A	ATSTK600-RC31 - STK600-RC044M-31	ATSTK600-SC06 - STK600-TQFP44	
ATmega16A	ATSTK600-RC31 - STK600-RC044M-31	ATSTK600-SC45 - STK600-QFN44	
ATmega16HVB	ATSTK600-RC24 - STK600-RC044M-24	ATSTK600-SC13 - STK600-TSSOP44	
ATmega16HVBrevB	ATSTK600-RC24 - STK600-RC044M-24	ATSTK600-SC13 - STK600-TSSOP44	
ATmega16M1	ATSTK600-RC22 - STK600-RCPWM-22	ATSTK600-SC10 - STK600-TQFP32	
ATmega16U2	ATSTK600-RC20 - STK600-RC032U-20	ATSTK600-SC12 - STK600-QFN32	
ATmega16U2	ATSTK600-RC20 - STK600-RC032U-20	ATSTK600-SC10 - STK600-TQFP32	
ATmega16U4	ATSTK600-RC25 - STK600-RC044U-25	ATSTK600-SC06 - STK600-TQFP44	
ATmega16U4	ATSTK600-RC25 - STK600-RC044U-25	ATSTK600-SC45 - STK600-QFN44	
ATmega2560	ATSTK600-RC11 - STK600-RC100M-11	ATSTK600-SC03 - STK600-TQFP100	
ATmega2561	ATSTK600-RC09 - STK600-RC064M-9	ATSTK600-SC02 - STK600-TQFP64	
ATmega2561	ATSTK600-RC09 - STK600-RC064M-9	ATSTK600-SC21 - STK600-QFN64	
ATmega32	ATSTK600-RC05 - STK600-RC040M-5	ATSTK600-SC01 - STK600-DIP	
ATmega32	ATSTK600-RC31 - STK600-RC044M-31	ATSTK600-SC06 - STK600-TQFP44	
ATmega32	ATSTK600-RC31 - STK600-RC044M-31	ATSTK600-SC45 - STK600-QFN44	

Device	Routing Card	Socket Card	Comment
ATmega3209	ATSTK600-RC107 - STK600-RC048M-107	ATSTK600-SC41 - STK600-QFN48	
ATmega3209	ATSTK600-RC107 - STK600-RC048M-107	ATSTK600-SC16 - STK600-TQFP48	
ATmega324A	ATSTK600-RC05 - STK600-RC040M-5	ATSTK600-SC01 - STK600-DIP	
ATmega324A	ATSTK600-RC31 - STK600-RC044M-31	ATSTK600-SC06 - STK600-TQFP44	
ATmega324A	ATSTK600-RC31 - STK600-RC044M-31	ATSTK600-SC45 - STK600-QFN44	
ATmega324P	ATSTK600-RC05 - STK600-RC040M-5	ATSTK600-SC01 - STK600-DIP	
ATmega324P	ATSTK600-RC31 - STK600-RC044M-31	ATSTK600-SC06 - STK600-TQFP44	
ATmega324P	ATSTK600-RC31 - STK600-RC044M-31	ATSTK600-SC45 - STK600-QFN44	
ATmega324PA	ATSTK600-RC05 - STK600-RC040M-5	ATSTK600-SC01 - STK600-DIP	
ATmega324PA	ATSTK600-RC31 - STK600-RC044M-31	ATSTK600-SC06 - STK600-TQFP44	
ATmega324PA	ATSTK600-RC31 - STK600-RC044M-31	ATSTK600-SC45 - STK600-QFN44	
ATmega324PB	ATSTK600-RC101 - STK600-RC044M-101	ATSTK600-SC06 - STK600-TQFP44	
ATmega324PB	ATSTK600-RC101 - STK600-RC044M-101	ATSTK600-SC45 - STK600-QFN44	
ATmega325	ATSTK600-RC10 - STK600-RC064M-10	ATSTK600-SC02 - STK600-TQFP64	
ATmega325	ATSTK600-RC10 - STK600-RC064M-10	ATSTK600-SC21 - STK600-QFN64	
ATmega3250	ATSTK600-RC18 - STK600-RC100M-18	ATSTK600-SC03 - STK600-TQFP100	
ATmega3250A	ATSTK600-RC18 - STK600-RC100M-18	ATSTK600-SC03 - STK600-TQFP100	
ATmega3250P	ATSTK600-RC18 - STK600-RC100M-18	ATSTK600-SC03 - STK600-TQFP100	
ATmega3250PA	ATSTK600-RC18 - STK600-RC100M-18	ATSTK600-SC03 - STK600-TQFP100	

Device	Routing Card	Socket Card	Comment
ATmega325A	ATSTK600-RC10 - STK600-RC064M-10	ATSTK600-SC02 - STK600-TQFP64	
ATmega325A	ATSTK600-RC10 - STK600-RC064M-10	ATSTK600-SC21 - STK600-QFN64	
ATmega325P	ATSTK600-RC10 - STK600-RC064M-10	ATSTK600-SC02 - STK600-TQFP64	
ATmega325P	ATSTK600-RC10 - STK600-RC064M-10	ATSTK600-SC21 - STK600-QFN64	
ATmega325PA	ATSTK600-RC10 - STK600-RC064M-10	ATSTK600-SC02 - STK600-TQFP64	
ATmega325PA	ATSTK600-RC10 - STK600-RC064M-10	ATSTK600-SC21 - STK600-QFN64	
ATmega328	ATSTK600-RC29 - STK600-RC032M-29	ATSTK600-SC10 - STK600-TQFP32	
ATmega328	ATSTK600-RC29 - STK600-RC032M-29	ATSTK600-SC12 - STK600-QFN32	
ATmega328	ATSTK600-RC06 - STK600-RC028M-6	ATSTK600-SC01 - STK600-DIP	
ATmega328P	ATSTK600-RC29 - STK600-RC032M-29	ATSTK600-SC10 - STK600-TQFP32	
ATmega328P	ATSTK600-RC29 - STK600-RC032M-29	ATSTK600-SC12 - STK600-QFN32	
ATmega328P	ATSTK600-RC06 - STK600-RC028M-6	ATSTK600-SC01 - STK600-DIP	
ATmega328PB	ATSTK600-RC91 - STK600-RC032M-91	ATSTK600-SC10 - STK600-TQFP32	
ATmega328PB	ATSTK600-RC91 - STK600-RC032M-91	ATSTK600-SC12 - STK600-QFN32	
ATmega329	ATSTK600-RC10 - STK600-RC064M-10	ATSTK600-SC02 - STK600-TQFP64	
ATmega329	ATSTK600-RC10 - STK600-RC064M-10	ATSTK600-SC21 - STK600-QFN64	
ATmega3290	ATSTK600-RC18 - STK600-RC100M-18	ATSTK600-SC03 - STK600-TQFP100	
ATmega3290A	ATSTK600-RC18 - STK600-RC100M-18	ATSTK600-SC03 - STK600-TQFP100	
ATmega3290P	ATSTK600-RC18 - STK600-RC100M-18	ATSTK600-SC03 - STK600-TQFP100	

Device	Routing Card	Socket Card	Comment
ATmega3290PA	ATSTK600-RC18 - STK600-RC100M-18	ATSTK600-SC03 - STK600-TQFP100	
ATmega329A	ATSTK600-RC10 - STK600-RC064M-10	ATSTK600-SC02 - STK600-TQFP64	
ATmega329A	ATSTK600-RC10 - STK600-RC064M-10	ATSTK600-SC21 - STK600-QFN64	
ATmega329P	ATSTK600-RC10 - STK600-RC064M-10	ATSTK600-SC02 - STK600-TQFP64	
ATmega329P	ATSTK600-RC10 - STK600-RC064M-10	ATSTK600-SC21 - STK600-QFN64	
ATmega329PA	ATSTK600-RC10 - STK600-RC064M-10	ATSTK600-SC02 - STK600-TQFP64	
ATmega329PA	ATSTK600-RC10 - STK600-RC064M-10	ATSTK600-SC21 - STK600-QFN64	
ATmega32A	ATSTK600-RC05 - STK600-RC040M-5	ATSTK600-SC01 - STK600-DIP	
ATmega32A	ATSTK600-RC31 - STK600-RC044M-31	ATSTK600-SC06 - STK600-TQFP44	
ATmega32A	ATSTK600-RC31 - STK600-RC044M-31	ATSTK600-SC45 - STK600-QFN44	
ATmega32C1	ATSTK600-RC22 - STK600-RCPWM-22	ATSTK600-SC10 - STK600-TQFP32	
ATmega32HVB	ATSTK600-RC24 - STK600-RC044M-24	ATSTK600-SC13 - STK600-TSSOP44	
ATmega32HVBrvB	ATSTK600-RC24 - STK600-RC044M-24	ATSTK600-SC13 - STK600-TSSOP44	
ATmega32M1	ATSTK600-RC22 - STK600-RCPWM-22	ATSTK600-SC10 - STK600-TQFP32	
ATmega32U2	ATSTK600-RC20 - STK600-RC032U-20	ATSTK600-SC12 - STK600-QFN32	
ATmega32U2	ATSTK600-RC20 - STK600-RC032U-20	ATSTK600-SC10 - STK600-TQFP32	
ATmega32U4	ATSTK600-RC25 - STK600-RC044U-25	ATSTK600-SC06 - STK600-TQFP44	
ATmega32U4	ATSTK600-RC25 - STK600-RC044U-25	ATSTK600-SC45 - STK600-QFN44	
ATmega48	ATSTK600-RC29 - STK600-RC032M-29	ATSTK600-SC10 - STK600-TQFP32	

# STK600 Starter Kit

## Device Support

Device	Routing Card	Socket Card	Comment
ATmega48	ATSTK600-RC29 - STK600-RC032M-29	ATSTK600-SC12 - STK600-QFN32	
ATmega48	ATSTK600-RC06 - STK600-RC028M-6	ATSTK600-SC01 - STK600-DIP	
ATmega4809	ATSTK600-RC107 - STK600-RC048M-107	ATSTK600-SC41 - STK600-QFN48	
ATmega4809	ATSTK600-RC107 - STK600-RC048M-107	ATSTK600-SC16 - STK600-TQFP48	
ATmega48A	ATSTK600-RC29 - STK600-RC032M-29	ATSTK600-SC10 - STK600-TQFP32	
ATmega48A	ATSTK600-RC29 - STK600-RC032M-29	ATSTK600-SC12 - STK600-QFN32	
ATmega48A	ATSTK600-RC06 - STK600-RC028M-6	ATSTK600-SC01 - STK600-DIP	
ATmega48P	ATSTK600-RC29 - STK600-RC032M-29	ATSTK600-SC10 - STK600-TQFP32	
ATmega48P	ATSTK600-RC29 - STK600-RC032M-29	ATSTK600-SC12 - STK600-QFN32	
ATmega48P	ATSTK600-RC06 - STK600-RC028M-6	ATSTK600-SC01 - STK600-DIP	
ATmega48PA	ATSTK600-RC29 - STK600-RC032M-29	ATSTK600-SC10 - STK600-TQFP32	
ATmega48PA	ATSTK600-RC29 - STK600-RC032M-29	ATSTK600-SC12 - STK600-QFN32	
ATmega48PA	ATSTK600-RC06 - STK600-RC028M-6	ATSTK600-SC01 - STK600-DIP	
ATmega48PB	ATSTK600-RC91 - STK600-RC032M-91	ATSTK600-SC10 - STK600-TQFP32	
ATmega48PB	ATSTK600-RC91 - STK600-RC032M-91	ATSTK600-SC12 - STK600-QFN32	
ATmega64	ATSTK600-RC09 - STK600-RC064M-9	ATSTK600-SC02 - STK600-TQFP64	
ATmega64	ATSTK600-RC09 - STK600-RC064M-9	ATSTK600-SC21 - STK600-QFN64	
ATmega640	ATSTK600-RC11 - STK600-RC100M-11	ATSTK600-SC03 - STK600-TQFP100	
ATmega644	ATSTK600-RC05 - STK600-RC040M-5	ATSTK600-SC01 - STK600-DIP	

Device	Routing Card	Socket Card	Comment
ATmega644	ATSTK600-RC31 - STK600-RC044M-31	ATSTK600-SC06 - STK600-TQFP44	
ATmega644	ATSTK600-RC31 - STK600-RC044M-31	ATSTK600-SC45 - STK600-QFN44	
ATmega644A	ATSTK600-RC05 - STK600-RC040M-5	ATSTK600-SC01 - STK600-DIP	
ATmega644A	ATSTK600-RC31 - STK600-RC044M-31	ATSTK600-SC06 - STK600-TQFP44	
ATmega644A	ATSTK600-RC31 - STK600-RC044M-31	ATSTK600-SC45 - STK600-QFN44	
ATmega644P	ATSTK600-RC05 - STK600-RC040M-5	ATSTK600-SC01 - STK600-DIP	
ATmega644P	ATSTK600-RC31 - STK600-RC044M-31	ATSTK600-SC06 - STK600-TQFP44	
ATmega644P	ATSTK600-RC31 - STK600-RC044M-31	ATSTK600-SC45 - STK600-QFN44	
ATmega644PA	ATSTK600-RC05 - STK600-RC040M-5	ATSTK600-SC01 - STK600-DIP	
ATmega644PA	ATSTK600-RC31 - STK600-RC044M-31	ATSTK600-SC06 - STK600-TQFP44	
ATmega644PA	ATSTK600-RC31 - STK600-RC044M-31	ATSTK600-SC45 - STK600-QFN44	
ATmega645	ATSTK600-RC10 - STK600-RC064M-10	ATSTK600-SC02 - STK600-TQFP64	
ATmega645	ATSTK600-RC10 - STK600-RC064M-10	ATSTK600-SC21 - STK600-QFN64	
ATmega6450	ATSTK600-RC18 - STK600-RC100M-18	ATSTK600-SC03 - STK600-TQFP100	
ATmega6450A	ATSTK600-RC18 - STK600-RC100M-18	ATSTK600-SC03 - STK600-TQFP100	
ATmega6450P	ATSTK600-RC18 - STK600-RC100M-18	ATSTK600-SC03 - STK600-TQFP100	
ATmega645A	ATSTK600-RC10 - STK600-RC064M-10	ATSTK600-SC02 - STK600-TQFP64	
ATmega645A	ATSTK600-RC10 - STK600-RC064M-10	ATSTK600-SC21 - STK600-QFN64	
ATmega645P	ATSTK600-RC10 - STK600-RC064M-10	ATSTK600-SC02 - STK600-TQFP64	

Device	Routing Card	Socket Card	Comment
ATmega645P	ATSTK600-RC10 - STK600-RC064M-10	ATSTK600-SC21 - STK600-QFN64	
ATmega649	ATSTK600-RC10 - STK600-RC064M-10	ATSTK600-SC02 - STK600-TQFP64	
ATmega649	ATSTK600-RC10 - STK600-RC064M-10	ATSTK600-SC21 - STK600-QFN64	
ATmega6490	ATSTK600-RC18 - STK600-RC100M-18	ATSTK600-SC03 - STK600-TQFP100	
ATmega6490A	ATSTK600-RC18 - STK600-RC100M-18	ATSTK600-SC03 - STK600-TQFP100	
ATmega6490P	ATSTK600-RC18 - STK600-RC100M-18	ATSTK600-SC03 - STK600-TQFP100	
ATmega649A	ATSTK600-RC10 - STK600-RC064M-10	ATSTK600-SC02 - STK600-TQFP64	
ATmega649A	ATSTK600-RC10 - STK600-RC064M-10	ATSTK600-SC21 - STK600-QFN64	
ATmega649P	ATSTK600-RC10 - STK600-RC064M-10	ATSTK600-SC02 - STK600-TQFP64	
ATmega649P	ATSTK600-RC10 - STK600-RC064M-10	ATSTK600-SC21 - STK600-QFN64	
ATmega64A	ATSTK600-RC09 - STK600-RC064M-9	ATSTK600-SC02 - STK600-TQFP64	
ATmega64A	ATSTK600-RC09 - STK600-RC064M-9	ATSTK600-SC21 - STK600-QFN64	
ATmega64C1	ATSTK600-RC22 - STK600-RCPWM-22	ATSTK600-SC10 - STK600-TQFP32	
ATmega64M1	ATSTK600-RC22 - STK600-RCPWM-22	ATSTK600-SC10 - STK600-TQFP32	
ATmega8	ATSTK600-RC29 - STK600-RC032M-29	ATSTK600-SC10 - STK600-TQFP32	
ATmega8	ATSTK600-RC29 - STK600-RC032M-29	ATSTK600-SC12 - STK600-QFN32	
ATmega8	ATSTK600-RC06 - STK600-RC028M-6	ATSTK600-SC01 - STK600-DIP	
ATmega8515	ATSTK600-RC30 - STK600-RC044M-30	ATSTK600-SC06 - STK600-TQFP44	
ATmega8515	ATSTK600-RC04 - STK600-RC040M-4	ATSTK600-SC01 - STK600-DIP	



Device	Routing Card	Socket Card	Comment
ATmega8515	ATSTK600-RC30 - STK600-RC044M-30	ATSTK600-SC45 - STK600-QFN44	
ATmega8535	ATSTK600-RC05 - STK600-RC040M-5	ATSTK600-SC01 - STK600-DIP	
ATmega8535	ATSTK600-RC31 - STK600-RC044M-31	ATSTK600-SC06 - STK600-TQFP44	
ATmega8535	ATSTK600-RC31 - STK600-RC044M-31	ATSTK600-SC45 - STK600-QFN44	
ATmega88	ATSTK600-RC29 - STK600-RC032M-29	ATSTK600-SC10 - STK600-TQFP32	
ATmega88	ATSTK600-RC29 - STK600-RC032M-29	ATSTK600-SC12 - STK600-QFN32	
ATmega88	ATSTK600-RC06 - STK600-RC028M-6	ATSTK600-SC01 - STK600-DIP	
ATmega88A	ATSTK600-RC29 - STK600-RC032M-29	ATSTK600-SC10 - STK600-TQFP32	
ATmega88A	ATSTK600-RC29 - STK600-RC032M-29	ATSTK600-SC12 - STK600-QFN32	
ATmega88A	ATSTK600-RC06 - STK600-RC028M-6	ATSTK600-SC01 - STK600-DIP	
ATmega88P	ATSTK600-RC29 - STK600-RC032M-29	ATSTK600-SC10 - STK600-TQFP32	
ATmega88P	ATSTK600-RC29 - STK600-RC032M-29	ATSTK600-SC12 - STK600-QFN32	
ATmega88P	ATSTK600-RC06 - STK600-RC028M-6	ATSTK600-SC01 - STK600-DIP	
ATmega88PA	ATSTK600-RC29 - STK600-RC032M-29	ATSTK600-SC10 - STK600-TQFP32	
ATmega88PA	ATSTK600-RC29 - STK600-RC032M-29	ATSTK600-SC12 - STK600-QFN32	
ATmega88PA	ATSTK600-RC06 - STK600-RC028M-6	ATSTK600-SC01 - STK600-DIP	
ATmega88PB	ATSTK600-RC91 - STK600-RC032M-91	ATSTK600-SC10 - STK600-TQFP32	
ATmega88PB	ATSTK600-RC91 - STK600-RC032M-91	ATSTK600-SC12 - STK600-QFN32	
ATmega8A	ATSTK600-RC29 - STK600-RC032M-29	ATSTK600-SC10 - STK600-TQFP32	

# STK600 Starter Kit

## Device Support

Device	Routing Card	Socket Card	Comment
ATmega8A	ATSTK600-RC29 - STK600-RC032M-29	ATSTK600-SC12 - STK600-QFN32	
ATmega8A	ATSTK600-RC06 - STK600-RC028M-6	ATSTK600-SC01 - STK600-DIP	
ATmega8U2	ATSTK600-RC20 - STK600-RC032U-20	ATSTK600-SC12 - STK600-QFN32	
ATmega8U2	ATSTK600-RC20 - STK600-RC032U-20	ATSTK600-SC10 - STK600-TQFP32	
ATtiny10		ATSTK600-ATTINY10 - STK600-ATTINY10	
ATtiny102	ATSTK600-RC102 - STK600-RC014T-102	ATSTK600-SC11 - STK600-SOIC	
ATtiny104	ATSTK600-RC102 - STK600-RC014T-102	ATSTK600-SC11 - STK600-SOIC	
ATtiny11	ATSTK600-RC02 - STK600-RC008T-2	ATSTK600-SC01 - STK600-DIP	
ATtiny12	ATSTK600-RC02 - STK600-RC008T-2	ATSTK600-SC01 - STK600-DIP	
ATtiny13	ATSTK600-RC02 - STK600-RC008T-2	ATSTK600-SC01 - STK600-DIP	
ATtiny13A	ATSTK600-RC02 - STK600-RC008T-2	ATSTK600-SC01 - STK600-DIP	
ATtiny1604	ATSTK600-RC104 - STK600-RC020T-104	ATSTK600-SC11 - STK600-SOIC	
ATtiny1606	ATSTK600-RC104 - STK600-RC020T-104	ATSTK600-SC11 - STK600-SOIC	
ATtiny1607	ATSTK600-RC103 - STK600-RC024T-103	ATSTK600-SC62 - STK600-QFN24	
ATtiny1614	ATSTK600-RC104 - STK600-RC020T-104	ATSTK600-SC11 - STK600-SOIC	
ATtiny1616	ATSTK600-RC104 - STK600-RC020T-104	ATSTK600-SC11 - STK600-SOIC	
ATtiny1617	ATSTK600-RC103 - STK600-RC024T-103	ATSTK600-SC62 - STK600-QFN24	
ATtiny1634	ATSTK600-RC54 - STK600-RC020T-54	ATSTK600-SC11 - STK600-SOIC	
ATtiny167	ATSTK600-RC23 - STK600-RC020T-23	ATSTK600-SC11 - STK600-SOIC	

Device	Routing Card	Socket Card	Comment
ATtiny20	ATSTK600-RC42 - STK600-RC014T-42	ATSTK600-SC11 - STK600-SOIC	
ATtiny204	ATSTK600-RC104 - STK600-RC020T-104	ATSTK600-SC11 - STK600-SOIC	
ATtiny214	ATSTK600-RC104 - STK600-RC020T-104	ATSTK600-SC11 - STK600-SOIC	
ATtiny2313	ATSTK600-RC01 - STK600-RC020T-1	ATSTK600-SC01 - STK600-DIP	
ATtiny2313A	ATSTK600-RC01 - STK600-RC020T-1	ATSTK600-SC01 - STK600-DIP	
ATtiny24	ATSTK600-RC12 - STK600-RC014T-12	ATSTK600-SC01 - STK600-DIP	
ATtiny24	ATSTK600-RC46 - STK600-RC014T-46	ATSTK600-SC11 - STK600-SOIC	
ATtiny24A	ATSTK600-RC12 - STK600-RC014T-12	ATSTK600-SC01 - STK600-DIP	
ATtiny24A	ATSTK600-RC46 - STK600-RC014T-46	ATSTK600-SC11 - STK600-SOIC	
ATtiny25	ATSTK600-RC02 - STK600-RC008T-2	ATSTK600-SC01 - STK600-DIP	
ATtiny26	ATSTK600-RC08 - STK600-RC020T-8	ATSTK600-SC01 - STK600-DIP	
ATtiny261	ATSTK600-RC08 - STK600-RC020T-8	ATSTK600-SC01 - STK600-DIP	
ATtiny261A	ATSTK600-RC08 - STK600-RC020T-8	ATSTK600-SC01 - STK600-DIP	
ATtiny3204	ATSTK600-RC104 - STK600-RC020T-104	ATSTK600-SC11 - STK600-SOIC	
ATtiny3206	ATSTK600-RC104 - STK600-RC020T-104	ATSTK600-SC11 - STK600-SOIC	
ATtiny3207	ATSTK600-RC103 - STK600-RC024T-103	ATSTK600-SC62 - STK600-QFN24	
ATtiny3214	ATSTK600-RC104 - STK600-RC020T-104	ATSTK600-SC11 - STK600-SOIC	
ATtiny3216	ATSTK600-RC104 - STK600-RC020T-104	ATSTK600-SC11 - STK600-SOIC	
ATtiny3217	ATSTK600-RC103 - STK600-RC024T-103	ATSTK600-SC62 - STK600-QFN24	

Device	Routing Card	Socket Card	Comment
ATtiny4		ATSTK600-ATTINY10 - STK600-ATTINY10	
ATtiny40	ATSTK600-RC44 - STK600-RC020T-44	ATSTK600-SC11 - STK600-SOIC	
ATtiny404	ATSTK600-RC104 - STK600-RC020T-104	ATSTK600-SC11 - STK600-SOIC	
ATtiny406	ATSTK600-RC104 - STK600-RC020T-104	ATSTK600-SC11 - STK600-SOIC	
ATtiny414	ATSTK600-RC104 - STK600-RC020T-104	ATSTK600-SC11 - STK600-SOIC	
ATtiny416	ATSTK600-RC104 - STK600-RC020T-104	ATSTK600-SC11 - STK600-SOIC	
ATtiny417	ATSTK600-RC103 - STK600-RC024T-103	ATSTK600-SC62 - STK600-QFN24	
ATtiny4313	ATSTK600-RC01 - STK600-RC020T-1	ATSTK600-SC01 - STK600-DIP	
ATtiny43U		ATSTK600-Tinyx3U - STK600-TINYX3U	
ATtiny44	ATSTK600-RC12 - STK600-RC014T-12	ATSTK600-SC01 - STK600-DIP	
ATtiny44	ATSTK600-RC46 - STK600-RC014T-46	ATSTK600-SC11 - STK600-SOIC	
ATtiny441	ATSTK600-RC46 - STK600-RC014T-46	ATSTK600-SC11 - STK600-SOIC	
ATtiny44A	ATSTK600-RC12 - STK600-RC014T-12	ATSTK600-SC01 - STK600-DIP	
ATtiny44A	ATSTK600-RC46 - STK600-RC014T-46	ATSTK600-SC11 - STK600-SOIC	
ATtiny45	ATSTK600-RC02 - STK600-RC008T-2	ATSTK600-SC01 - STK600-DIP	
ATtiny461	ATSTK600-RC08 - STK600-RC020T-8	ATSTK600-SC01 - STK600-DIP	
ATtiny461A	ATSTK600-RC08 - STK600-RC020T-8	ATSTK600-SC01 - STK600-DIP	
ATtiny48	ATSTK600-RC06 - STK600-RC028M-6	ATSTK600-SC01 - STK600-DIP	
ATtiny48	ATSTK600-RC45 - STK600-RC032T-45	ATSTK600-SC10 - STK600-TQFP32	

# STK600 Starter Kit

## Device Support

Device	Routing Card	Socket Card	Comment
ATtiny48	ATSTK600-RC45 - STK600-RC032T-45	ATSTK600-SC12 - STK600-QFN32	
ATtiny5		ATSTK600-ATTINY10 - STK600-ATTINY10	
ATtiny804	ATSTK600-RC104 - STK600-RC020T-104	ATSTK600-SC11 - STK600-SOIC	
ATtiny806	ATSTK600-RC104 - STK600-RC020T-104	ATSTK600-SC11 - STK600-SOIC	
ATtiny807	ATSTK600-RC103 - STK600-RC024T-103	ATSTK600-SC62 - STK600-QFN24	
ATtiny814	ATSTK600-RC104 - STK600-RC020T-104	ATSTK600-SC11 - STK600-SOIC	
ATtiny816	ATSTK600-RC104 - STK600-RC020T-104	ATSTK600-SC11 - STK600-SOIC	
ATtiny817	ATSTK600-RC103 - STK600-RC024T-103	ATSTK600-SC62 - STK600-QFN24	
ATtiny828	ATSTK600-RC56 - STK600-RC032T-56	ATSTK600-SC10 - STK600-TQFP32	
ATtiny828	ATSTK600-RC56 - STK600-RC032T-56	ATSTK600-SC12 - STK600-QFN32	
ATtiny84	ATSTK600-RC12 - STK600-RC014T-12	ATSTK600-SC01 - STK600-DIP	
ATtiny84	ATSTK600-RC46 - STK600-RC014T-46	ATSTK600-SC11 - STK600-SOIC	
ATtiny841	ATSTK600-RC46 - STK600-RC014T-46	ATSTK600-SC11 - STK600-SOIC	
ATtiny84A	ATSTK600-RC12 - STK600-RC014T-12	ATSTK600-SC01 - STK600-DIP	
ATtiny84A	ATSTK600-RC46 - STK600-RC014T-46	ATSTK600-SC11 - STK600-SOIC	
ATtiny85	ATSTK600-RC02 - STK600-RC008T-2	ATSTK600-SC01 - STK600-DIP	
ATtiny861	ATSTK600-RC08 - STK600-RC020T-8	ATSTK600-SC01 - STK600-DIP	
ATtiny861A	ATSTK600-RC08 - STK600-RC020T-8	ATSTK600-SC01 - STK600-DIP	
ATtiny87	ATSTK600-RC23 - STK600-RC020T-23	ATSTK600-SC11 - STK600-SOIC	

Device	Routing Card	Socket Card	Comment
ATtiny88	ATSTK600-RC06 - STK600-RC028M-6	ATSTK600-SC01 - STK600-DIP	
ATtiny88	ATSTK600-RC45 - STK600-RC032T-45	ATSTK600-SC10 - STK600-TQFP32	
ATtiny88	ATSTK600-RC45 - STK600-RC032T-45	ATSTK600-SC12 - STK600-QFN32	
ATtiny9		ATSTK600-ATTINY10 - STK600-ATTINY10	
ATxmega128A1	ATSTK600-RC13 - STK600-RC100X-13	ATSTK600-SC03 - STK600-TQFP100	
ATxmega128A1	ATSTK600-RC13 - STK600-RC100X-13	ATSTK600-SC03 - STK600-TQFP100	
ATxmega128A1U	ATSTK600-RC13 - STK600-RC100X-13	ATSTK600-SC03 - STK600-TQFP100	since rev.10 (A09-0117/10)
ATxmega128A1U	ATSTK600-RC13 - STK600-RC100X-13	ATSTK600-SC03 - STK600-TQFP100	since rev.10 (A09-0117.10)
ATxmega128A3	ATSTK600-RC14 - STK600-RC064X-14	ATSTK600-SC02 - STK600-TQFP64	
ATxmega128A3	ATSTK600-RC51 - STK600-RC064X-51	ATSTK600-SC02 - STK600-TQFP64	
ATxmega128A3	ATSTK600-RC14 - STK600-RC064X-14	ATSTK600-SC21 - STK600-QFN64	
ATxmega128A3	ATSTK600-RC51 - STK600-RC064X-51	ATSTK600-SC21 - STK600-QFN64	
ATxmega128A3U	ATSTK600-RC51 - STK600-RC064X-51	ATSTK600-SC02 - STK600-TQFP64	
ATxmega128A3U	ATSTK600-RC51 - STK600-RC064X-51	ATSTK600-SC21 - STK600-QFN64	
ATxmega128A4U	ATSTK600-RC55 - STK600-RC044X-55	ATSTK600-SC06 - STK600-TQFP44	
ATxmega128A4U	ATSTK600-RC55 - STK600-RC044X-55	ATSTK600-SC45 - STK600-QFN44	
ATxmega128B1	ATSTK600-RC50 - STK600-RC100X-50	ATSTK600-SC03 - STK600-TQFP100	
ATxmega128B3	ATSTK600-RC52 - STK600-RC064X-52	ATSTK600-SC21 - STK600-QFN64	
ATxmega128B3	ATSTK600-RC52 - STK600-RC064X-52	ATSTK600-SC02 - STK600-TQFP64	

# STK600 Starter Kit

## Device Support

Device	Routing Card	Socket Card	Comment
ATxmega128C3	ATSTK600-RC51 - STK600-RC064X-51	ATSTK600-SC02 - STK600-TQFP64	
ATxmega128C3	ATSTK600-RC51 - STK600-RC064X-51	ATSTK600-SC21 - STK600-QFN64	
ATxmega128D3	ATSTK600-RC14 - STK600-RC064X-14	ATSTK600-SC02 - STK600-TQFP64	
ATxmega128D3	ATSTK600-RC14 - STK600-RC064X-14	ATSTK600-SC21 - STK600-QFN64	
ATxmega128D4	ATSTK600-RC15 - STK600-RC044X-15	ATSTK600-SC06 - STK600-TQFP44	
ATxmega128D4	ATSTK600-RC15 - STK600-RC044X-15	ATSTK600-SC45 - STK600-QFN44	
ATxmega16A4	ATSTK600-RC55 - STK600-RC044X-55	ATSTK600-SC06 - STK600-TQFP44	
ATxmega16A4	ATSTK600-RC55 - STK600-RC044X-55	ATSTK600-SC45 - STK600-QFN44	
ATxmega16A4	ATSTK600-RC15 - STK600-RC044X-15	ATSTK600-SC06 - STK600-TQFP44	
ATxmega16A4	ATSTK600-RC15 - STK600-RC044X-15	ATSTK600-SC45 - STK600-QFN44	
ATxmega16A4U	ATSTK600-RC55 - STK600-RC044X-55	ATSTK600-SC06 - STK600-TQFP44	
ATxmega16A4U	ATSTK600-RC55 - STK600-RC044X-55	ATSTK600-SC45 - STK600-QFN44	
ATxmega16C4	ATSTK600-RC55 - STK600-RC044X-55	ATSTK600-SC06 - STK600-TQFP44	
ATxmega16C4	ATSTK600-RC55 - STK600-RC044X-55	ATSTK600-SC45 - STK600-QFN44	
ATxmega16D4	ATSTK600-RC15 - STK600-RC044X-15	ATSTK600-SC06 - STK600-TQFP44	
ATxmega16D4	ATSTK600-RC15 - STK600-RC044X-15	ATSTK600-SC45 - STK600-QFN44	
ATxmega16E5	ATSTK600-RC64 - STK600-RC032X-64	ATSTK600-SC10 - STK600-TQFP32	
ATxmega16E5	ATSTK600-RC64 - STK600-RC032X-64	ATSTK600-SC12 - STK600-QFN32	
ATxmega192A3	ATSTK600-RC14 - STK600-RC064X-14	ATSTK600-SC02 - STK600-TQFP64	

Device	Routing Card	Socket Card	Comment
ATxmega192A3	ATSTK600-RC51 - STK600-RC064X-51	ATSTK600-SC02 - STK600-TQFP64	
ATxmega192A3	ATSTK600-RC14 - STK600-RC064X-14	ATSTK600-SC21 - STK600-QFN64	
ATxmega192A3	ATSTK600-RC51 - STK600-RC064X-51	ATSTK600-SC21 - STK600-QFN64	
ATxmega192A3U	ATSTK600-RC51 - STK600-RC064X-51	ATSTK600-SC02 - STK600-TQFP64	
ATxmega192A3U	ATSTK600-RC51 - STK600-RC064X-51	ATSTK600-SC21 - STK600-QFN64	
ATxmega192C3	ATSTK600-RC51 - STK600-RC064X-51	ATSTK600-SC02 - STK600-TQFP64	
ATxmega192C3	ATSTK600-RC51 - STK600-RC064X-51	ATSTK600-SC21 - STK600-QFN64	
ATxmega192D3	ATSTK600-RC14 - STK600-RC064X-14	ATSTK600-SC02 - STK600-TQFP64	
ATxmega192D3	ATSTK600-RC14 - STK600-RC064X-14	ATSTK600-SC21 - STK600-QFN64	
ATxmega256A3	ATSTK600-RC14 - STK600-RC064X-14	ATSTK600-SC02 - STK600-TQFP64	
ATxmega256A3	ATSTK600-RC51 - STK600-RC064X-51	ATSTK600-SC02 - STK600-TQFP64	
ATxmega256A3	ATSTK600-RC14 - STK600-RC064X-14	ATSTK600-SC21 - STK600-QFN64	
ATxmega256A3	ATSTK600-RC51 - STK600-RC064X-51	ATSTK600-SC21 - STK600-QFN64	
ATxmega256A3B	ATSTK600-RC14 - STK600-RC064X-14	ATSTK600-SC02 - STK600-TQFP64	
ATxmega256A3B	ATSTK600-RC51 - STK600-RC064X-51	ATSTK600-SC02 - STK600-TQFP64	
ATxmega256A3B	ATSTK600-RC14 - STK600-RC064X-14	ATSTK600-SC21 - STK600-QFN64	
ATxmega256A3B	ATSTK600-RC51 - STK600-RC064X-51	ATSTK600-SC21 - STK600-QFN64	
ATxmega256A3B U	ATSTK600-RC51 - STK600-RC064X-51	ATSTK600-SC02 - STK600-TQFP64	
ATxmega256A3B U	ATSTK600-RC51 - STK600-RC064X-51	ATSTK600-SC21 - STK600-QFN64	



# STK600 Starter Kit

## Device Support

Device	Routing Card	Socket Card	Comment
ATxmega256A3U	ATSTK600-RC51 - STK600-RC064X-51	ATSTK600-SC02 - STK600-TQFP64	
ATxmega256A3U	ATSTK600-RC51 - STK600-RC064X-51	ATSTK600-SC21 - STK600-QFN64	
ATxmega256C3	ATSTK600-RC51 - STK600-RC064X-51	ATSTK600-SC02 - STK600-TQFP64	
ATxmega256C3	ATSTK600-RC51 - STK600-RC064X-51	ATSTK600-SC21 - STK600-QFN64	
ATxmega256D3	ATSTK600-RC14 - STK600-RC064X-14	ATSTK600-SC02 - STK600-TQFP64	
ATxmega256D3	ATSTK600-RC14 - STK600-RC064X-14	ATSTK600-SC21 - STK600-QFN64	
ATxmega32A4	ATSTK600-RC55 - STK600-RC044X-55	ATSTK600-SC06 - STK600-TQFP44	
ATxmega32A4	ATSTK600-RC55 - STK600-RC044X-55	ATSTK600-SC45 - STK600-QFN44	
ATxmega32A4	ATSTK600-RC15 - STK600-RC044X-15	ATSTK600-SC06 - STK600-TQFP44	
ATxmega32A4	ATSTK600-RC15 - STK600-RC044X-15	ATSTK600-SC45 - STK600-QFN44	
ATxmega32A4U	ATSTK600-RC55 - STK600-RC044X-55	ATSTK600-SC06 - STK600-TQFP44	
ATxmega32A4U	ATSTK600-RC55 - STK600-RC044X-55	ATSTK600-SC45 - STK600-QFN44	
ATxmega32C3	ATSTK600-RC51 - STK600-RC064X-51	ATSTK600-SC02 - STK600-TQFP64	
ATxmega32C3	ATSTK600-RC51 - STK600-RC064X-51	ATSTK600-SC21 - STK600-QFN64	
ATxmega32C4	ATSTK600-RC55 - STK600-RC044X-55	ATSTK600-SC06 - STK600-TQFP44	
ATxmega32C4	ATSTK600-RC55 - STK600-RC044X-55	ATSTK600-SC45 - STK600-QFN44	
ATxmega32D3	ATSTK600-RC14 - STK600-RC064X-14	ATSTK600-SC02 - STK600-TQFP64	
ATxmega32D3	ATSTK600-RC14 - STK600-RC064X-14	ATSTK600-SC21 - STK600-QFN64	
ATxmega32D4	ATSTK600-RC15 - STK600-RC044X-15	ATSTK600-SC06 - STK600-TQFP44	

# STK600 Starter Kit

## Device Support

Device	Routing Card	Socket Card	Comment
ATxmega32D4	ATSTK600-RC15 - STK600-RC044X-15	ATSTK600-SC45 - STK600-QFN44	
ATxmega32E5	ATSTK600-RC64 - STK600-RC032X-64	ATSTK600-SC10 - STK600-TQFP32	
ATxmega32E5	ATSTK600-RC64 - STK600-RC032X-64	ATSTK600-SC12 - STK600-QFN32	
ATxmega384C3	ATSTK600-RC51 - STK600-RC064X-51	ATSTK600-SC02 - STK600-TQFP64	
ATxmega384C3	ATSTK600-RC51 - STK600-RC064X-51	ATSTK600-SC21 - STK600-QFN64	
ATxmega384D3	ATSTK600-RC14 - STK600-RC064X-14	ATSTK600-SC02 - STK600-TQFP64	
ATxmega384D3	ATSTK600-RC51 - STK600-RC064X-51	ATSTK600-SC02 - STK600-TQFP64	
ATxmega384D3	ATSTK600-RC14 - STK600-RC064X-14	ATSTK600-SC21 - STK600-QFN64	
ATxmega384D3	ATSTK600-RC51 - STK600-RC064X-51	ATSTK600-SC21 - STK600-QFN64	
ATxmega64A1	ATSTK600-RC13 - STK600-RC100X-13	ATSTK600-SC03 - STK600-TQFP100	
ATxmega64A1	ATSTK600-RC13 - STK600-RC100X-13	ATSTK600-SC03 - STK600-TQFP100	
ATxmega64A1U	ATSTK600-RC13 - STK600-RC100X-13	ATSTK600-SC03 - STK600-TQFP100	since rev.10 (A09-0117.10)
ATxmega64A1U	ATSTK600-RC13 - STK600-RC100X-13	ATSTK600-SC03 - STK600-TQFP100	since rev.10 (A09-0117.10)
ATxmega64A3	ATSTK600-RC14 - STK600-RC064X-14	ATSTK600-SC02 - STK600-TQFP64	
ATxmega64A3	ATSTK600-RC51 - STK600-RC064X-51	ATSTK600-SC02 - STK600-TQFP64	
ATxmega64A3	ATSTK600-RC14 - STK600-RC064X-14	ATSTK600-SC21 - STK600-QFN64	
ATxmega64A3	ATSTK600-RC51 - STK600-RC064X-51	ATSTK600-SC21 - STK600-QFN64	
ATxmega64A3U	ATSTK600-RC51 - STK600-RC064X-51	ATSTK600-SC02 - STK600-TQFP64	
ATxmega64A3U	ATSTK600-RC51 - STK600-RC064X-51	ATSTK600-SC21 - STK600-QFN64	

# STK600 Starter Kit

## Device Support

Device	Routing Card	Socket Card	Comment
ATxmega64A4U	ATSTK600-RC55 - STK600-RC044X-55	ATSTK600-SC06 - STK600-TQFP44	
ATxmega64A4U	ATSTK600-RC55 - STK600-RC044X-55	ATSTK600-SC45 - STK600-QFN44	
ATxmega64B1	ATSTK600-RC50 - STK600-RC100X-50	ATSTK600-SC03 - STK600-TQFP100	
ATxmega64B3	ATSTK600-RC52 - STK600-RC064X-52	ATSTK600-SC21 - STK600-QFN64	
ATxmega64B3	ATSTK600-RC52 - STK600-RC064X-52	ATSTK600-SC02 - STK600-TQFP64	
ATxmega64C3	ATSTK600-RC51 - STK600-RC064X-51	ATSTK600-SC02 - STK600-TQFP64	
ATxmega64C3	ATSTK600-RC51 - STK600-RC064X-51	ATSTK600-SC21 - STK600-QFN64	
ATxmega64D3	ATSTK600-RC14 - STK600-RC064X-14	ATSTK600-SC02 - STK600-TQFP64	
ATxmega64D3	ATSTK600-RC14 - STK600-RC064X-14	ATSTK600-SC21 - STK600-QFN64	
ATxmega64D3	ATSTK600-RC14 - STK600-RC064X-14	ATSTK600-SC14 - STK600-TQFP64-2	
ATxmega64D4	ATSTK600-RC15 - STK600-RC044X-15	ATSTK600-SC06 - STK600-TQFP44	
ATxmega64D4	ATSTK600-RC15 - STK600-RC044X-15	ATSTK600-SC45 - STK600-QFN44	
ATxmega8E5	ATSTK600-RC64 - STK600-RC032X-64	ATSTK600-SC10 - STK600-TQFP32	
ATxmega8E5	ATSTK600-RC64 - STK600-RC032X-64	ATSTK600-SC12 - STK600-QFN32	

## 4. Getting Started

### 4.1 Kit Contents

The box contains:

- STK600 Starter Kit Evaluation Board
- Cables for STK600:
  - Two 10-wire cables for I/O ports and Parallel mode programming
  - One 6-wire cable for in-system programming
  - Four 2-wire cables for UART and DataFlash connections
- USB Cable
- DC Power Cable
- Device Board with an ATmega2560 Device
- Two Sets of Screws and Nuts, and One Set of Clips

### 4.2 Quick Start

The STK600 Starter Kit is shipped with a device board with an ATmega2560 microcontroller.

The STK600 can source power to the microcontroller through the USB cable. Remember that the power available through the USB cable is limited. If your application attaches several peripherals to the STK600, you should use an external power source connected to the DC input socket on STK600. The external power supply should be 9-15V DC with positive center connector.

The power switch turns the STK600 main power ON and OFF. The red LED is lit when power is ON, and the status LED will turn green. The green LED beside the VTG jumper indicates that the target voltage is present.



### 4.3 Connecting the Hardware

The STK600 must be connected to a host PC with a USB cable. Connect the cable to a free USB port on the PC or on a USB hub. The USB port must be capable of supplying 500 mA. If using a USB hub, make sure it has an external power supply.

Connect the other end of the USB cable to the USB connector on the STK600 sitting next to the DC jack.

Optionally, if STK600 is to be connected to external hardware that consumes more than 300 mA, an external DC power supply can be connected to the DC jack on the STK600. The cable supplied with the kit can be used. Connect the center pin to the positive voltage and the cap to ground.

See [5. Target Socket System](#) on how to set up the routing card and socket card.





A *routing card* is a device-specific card. It routes signals between the STK600 motherboard and the socket card. Note that several devices may use the same routing card if they share the same pinout.



A set of spring loaded connectors makes the connection between the motherboard, routing card, and socket card. Clips or screws hold the stack of cards together.



In addition to the socket and routing cards included in the kit, there are several add-on packs available to expand the part support for the STK600. See the [3. Device Support](#) page to get an overview of the different socket and routing cards.

### 5.3 Selecting the Correct Routing and Socket Cards

Selecting the correct routing and socket card can be done by looking at the [3. Device Support](#) table.

For Atmel Studio the correct routing and socket card can also be found by selecting the correct device in the STK600 programming dialog in Atmel Studio. A notification will display the correct routing and socket



card to use unless the STK600 already has the correct cards mounted. More information on the programming dialog can be found in the *Programming Dialog* pages in the Atmel Studio help.

Note that some of the devices have a part-specific socket card (i.e., a routing card that has a socket). In this case, there is only one card to install onto the motherboard.

## 5.4 Mounting the Cards

Mounting the routing and socket cards can either be done by plastic clips or plastic screws/nuts. Both sets are included in the STK600 package. Install either the clips or the nuts to the motherboard depending on what solution you want to use.

### 5.4.1 Using Clips

#### 5.4.1.1 Motherboard

The clips should be installed from the bottom side of the STK600 motherboard. When properly installed, two plastic locking springs hold the clip in place.

# STK600 Starter Kit

## Target Socket System



### 5.4.1.2 Routing Card

Align the clips with the white lines on the motherboard. The routing card can now be placed above the four clips. Make sure that the routing card has the correct orientation (i.e., the text should face upwards, and the white dot in the corner should match the one on the STK600). Press down the routing card (i.e., compress the spring loaded connector on the STK600) and turn the clip 45 degrees in the clockwise direction so that it aligns with the white line on the routing card. It is easiest to do two opposite clips before locking the last two.

# STK600 Starter Kit

## Target Socket System

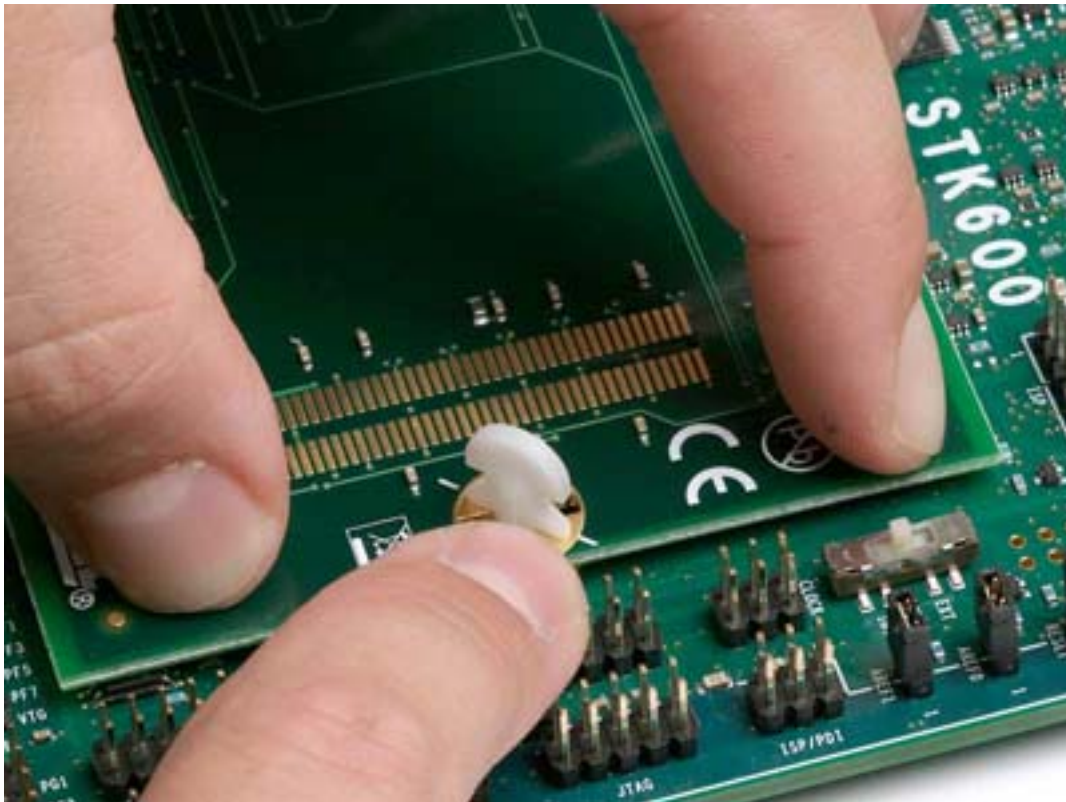
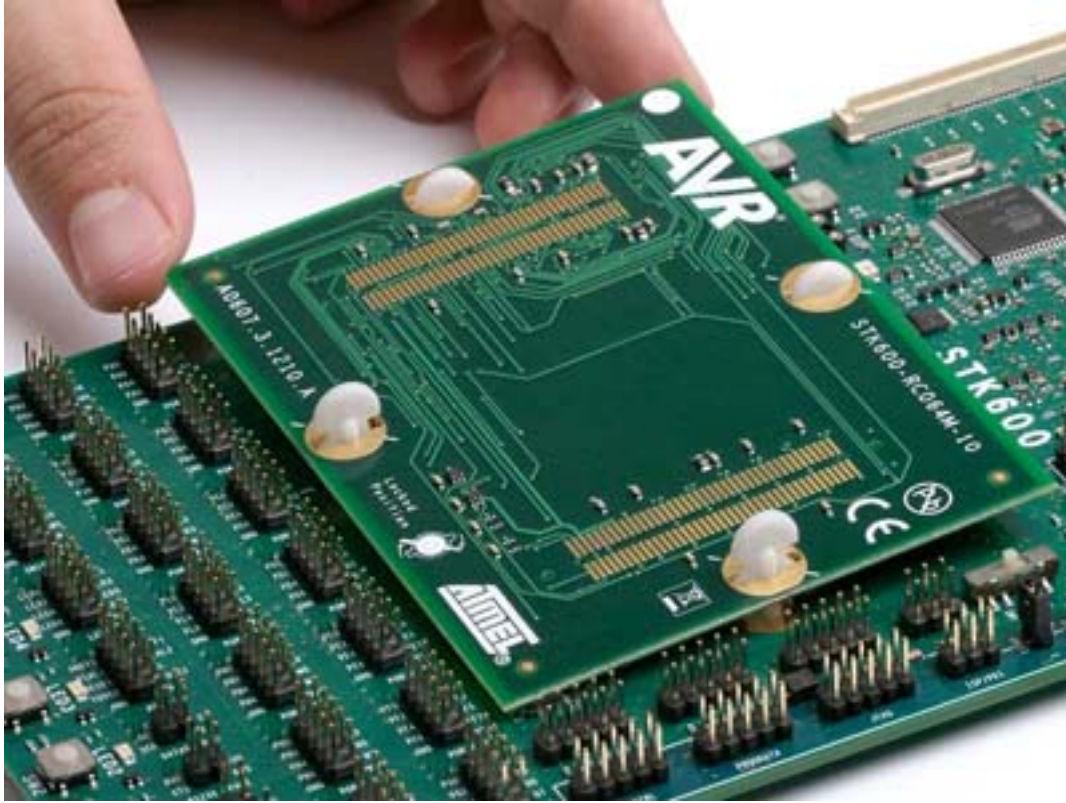

# STK600 Starter Kit

## Target Socket System

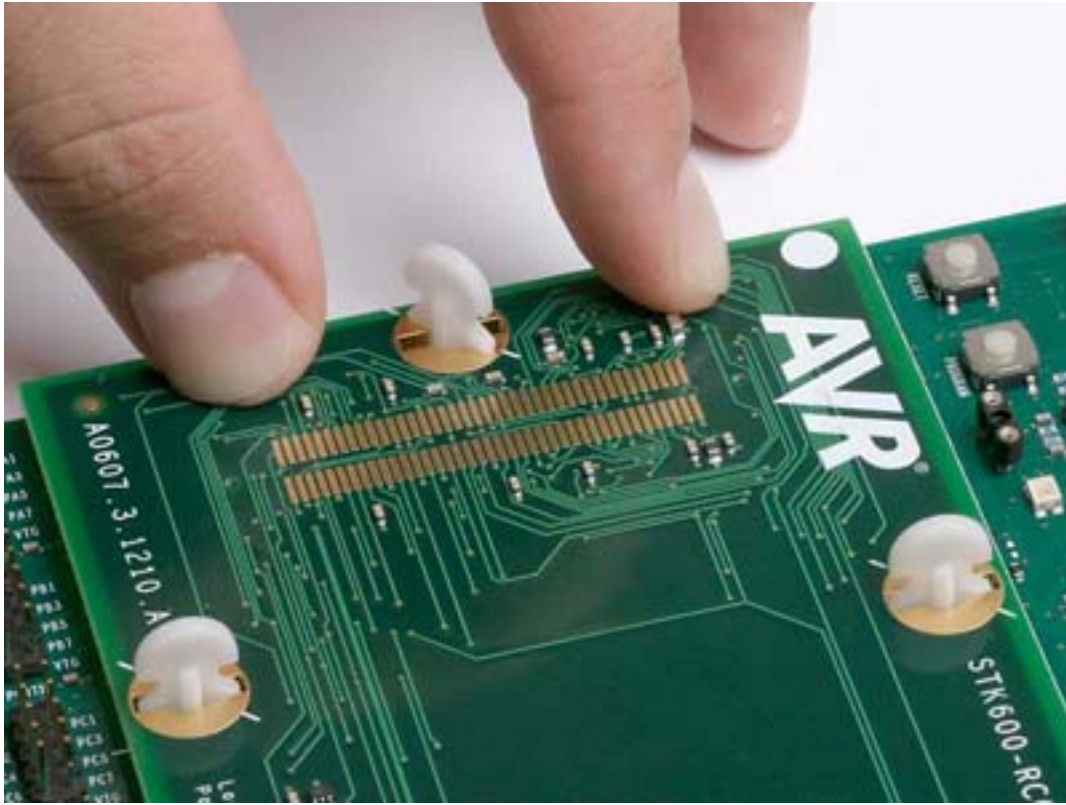

### 5.4.1.3 Socket Card

Connecting the socket card is done in the same way as the routing card. Make sure that the clips align with the white line outside the clip holes on the routing card, then mount the socket card. The white spot on the socket card should align with the one on the routing card. Press down the socket card (i.e., compress the spring loaded connector on the socket card) and turn the clip 45 degrees in the clockwise direction until it aligns with the white line outside the clip hole. It is easiest to do two opposite clips before locking the last two.

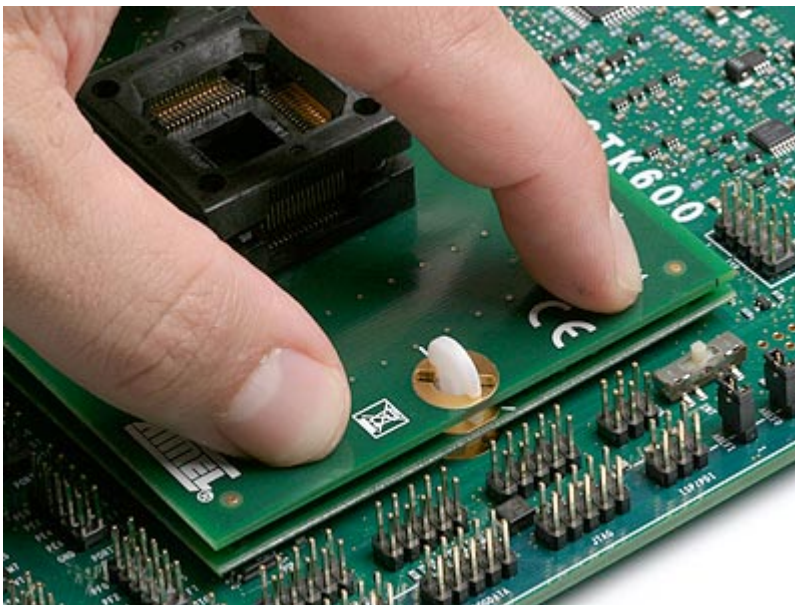
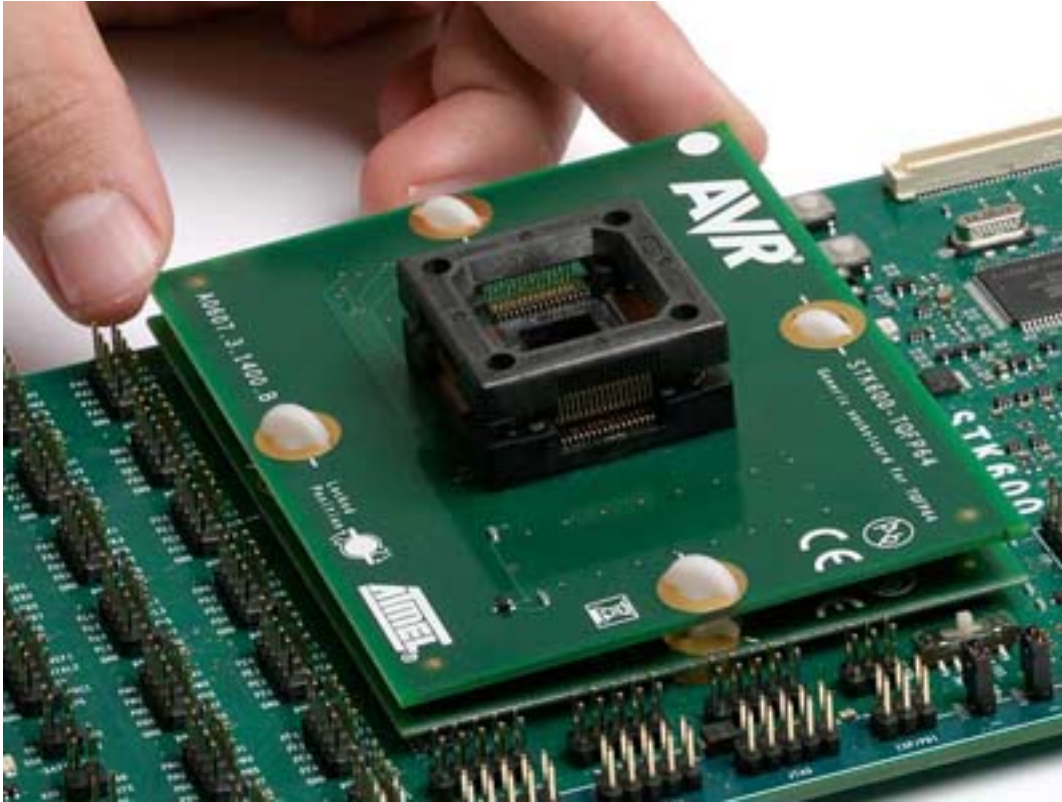

**Note:**

Always rotate the clips within the 45 degrees window. Do not turn them around, that could cause the routing card below to unlock from the clip.

### 5.4.2 Using Screws and Nuts

#### 5.4.2.1 Motherboard

Insert the nuts into the STK600 motherboard from the bottom side. When properly installed the two locking springs should hold the nut in place.

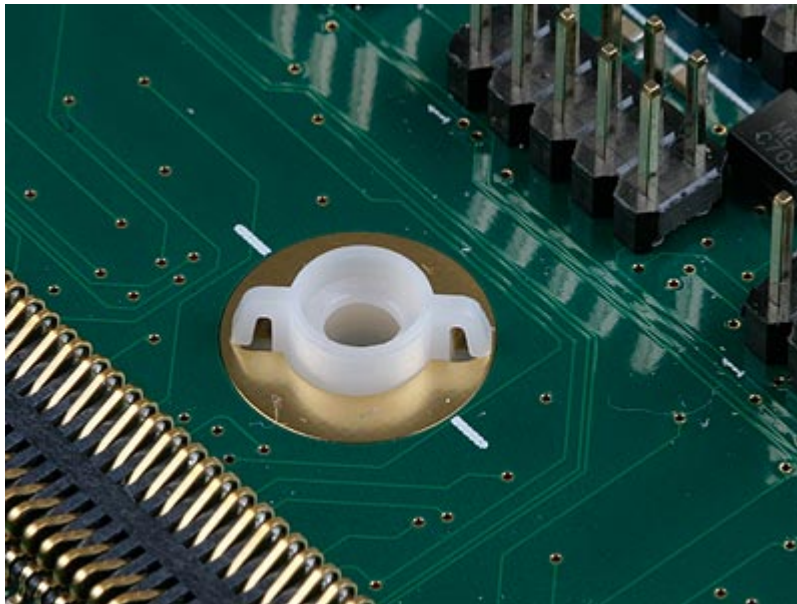

#### 5.4.2.2 Routing and Socket Card

Place the routing card above the motherboard, make sure that the white spot in the corner matches the white spot on the motherboard. The small plastic taps on the ends of the spring loaded connectors should mate with the holes in the routing card. When the routing card is in the correct position, place the socket card onto the routing card with the white spot matching the one on the routing card. Make sure that the plastic taps on the connectors on the socket card mates with the routing card as well.

Insert the four screws, and tighten them firmly into the nuts.



### 5.5 Signal Integrity

STK600 is designed to support a wide range of devices with different packages and pinouts. Many compromises have been taken to make this possible with one motherboard. The signal integrity is not optimized due to this. STK600 is not a reference design in any way, but a kit that serves as socket programmer with some additional peripheral hardware to get started with the AVR device. Serial communication at the highest frequencies may not work.

### 5.6 AVR UC3 Routing Card Pin Mapping

STK600-RCUC3B0-21

Device Pin Name	STK600 Pin Name
PA10	PB2
PA11	PB3, TOSC1
PA12	TOSC2, PB4
PA13	PB5
PA14	PB6, MOSI
PA15	PB7, SCK
PA16	PC0
PA17	PC1
PA18	XTAL1, PC2
PA19	PC3, XTAL2
PA20	PC4



# STK600 Starter Kit

## Target Socket System

Device Pin Name	STK600 Pin Name
PA21	PC5
PA22	PC6
PA23	PC7
PA24	PD0
PA25	PD1, MISO
PA26	PD2
PA27	PD3
PA28	PD4
PA29	PD5
PA30	PD6
PA31	PD7
PA3	PA3
PA4	PA4
PA5	PA5
PA6	PA6
PA7	PA7
PA8	PB0
PA9	PB1
PB0	PE0
PB10	PF2
PB11	PF3
PB1	PE1
PB2	PE2
PB3	PE3
PB4	PE4
PB5	PE5
PB6	PE6
PB7	PE7
PB8	PF0
PB9	PF1
RESET	RESET
TCK	TCK

# STK600 Starter Kit

## Target Socket System

Device Pin Name	STK600 Pin Name
TDI	TDI
TDO	TDO
TMS	TMS
AREF0	AREF0
DN	DN
DP	DP
VBUS	VBUST
VDDANA	VTG
VDDCORE	
VDDIN	VTG
VDDOUT	
VDDPLL	
GND	GND

### STK600-RCUC3B48-27

Device Pin Name	STK600 Pin Name
PA10	PB2
PA11	PB3, TOSC1
PA12	TOSC2, PB4
PA13	PB5
PA14	PB6, MOSI
PA15	PB7, SCK
PA16	PC0
PA17	PC1
PA18	XTAL1, PC2
PA19	PC3, XTAL2
PA20	PC4
PA21	PC5
PA22	PC6
PA23	PC7
PA24	PD0
PA25	PD1, MISO

# STK600 Starter Kit

## Target Socket System

Device Pin Name	STK600 Pin Name
PA26	PD2
PA27	PD3
PA3	PA3
PA4	PA4
PA5	PA5
PA6	PA6
PA7	PA7
PA8	PB0
PA9	PB1
RESET	RESET
TCK	TCK
TDI	TDI
TDO	TDO
TMS	TMS
AREF0	AREF0
DN	DN
DP	DP
VBUS	VBUST
VDDANA	VTG
VDDCORE	
VDDIN	VTG
VDDOUT	
VDDPLL	
GND	GND

### STK600-RCUC3A100-28

Device Pin Name	STK600 Pin Name
PA00	PA0
PA01	PA1
PA02	PA2
PA03	PA3
PA04	PA4

# STK600 Starter Kit

## Target Socket System

Device Pin Name	STK600 Pin Name
PA05	PA5
PA06	PA6
PA07	PA7
PA08	PB0
PA09	PB1
PA10	PB2
PA11	PB3, MISO
PA12	PB4, MOSI
PA13	PB5, SCK
PA14	PB6
PA15	PB7
PA16	PC0
PA17	PC1
PA18	PC2
PA19	PC3
PA20	PC4
PA21	PC5
PA22	PC6
PA23	PC7
PA24	PD0
PA25	PD1
PA26	PD2
PA27	PD3
PA28	PD4
PA29	PD5
PA31	PD7
PB00	PE0
PB01	PE1
PB02	PE2
PB03	PE3
PB04	PE4
PB05	PE5

# STK600 Starter Kit

## Target Socket System

Device Pin Name	STK600 Pin Name
PB06	PE6
PB07	PE7
PB08	PF0
PB09	PF1
PB10	PF2
PB11	PF3
PB12	PF4
PB13	PF5
PB14	PF6
PB15	PF7
PB16	PG0
PB17	PG1
PB18	PG2
PB19	PG3
PB20	PG4
PB21	PG5
PB22	PG6
PB23	PG7
PB24	PH0
PB25	PH1
PB26	PH2
PB27	PH3
PB28	PH4
PB29	PH5
PB30	PH6
PB31	PH7
PC00	TOSC1
PC01	TOSC2
PC02	XTAL1
PC03	XTAL2
PC04	
PC05	

# STK600 Starter Kit

## Target Socket System

Device Pin Name	STK600 Pin Name
AREF0	AREF0
DN	DN
DP	DP
RESET	RESET
TCK	TCK
TDI	TDI
TDO	TDO
TMS	TMS
VBUS	VBUST
VDDANA	VTG
VDDCORE	
VDDIN	VTG
VDDPLL	
GND	GND

### STK600-RCUC3A144-32

Device Pin Name	STK600 Pin Name
PA00	PA0
PA01	PA1
PA02	PA2
PA03	PA3
PA04	PA4
PA05	PA5
PA06	PA6, UVCON
PA07	PA7
PA08	PB0, SCK
PA09	PB1
PA10	PB2, MOSI
PA11	PB3, MISO
PA12	PB4
PA13	PB5
PA14	PB6

# STK600 Starter Kit

## Target Socket System

Device Pin Name	STK600 Pin Name
PA15	PB7
PA16	PC0
PA17	PC1
PA18	PC2
PA19	PC3
PA20	PC4
PA21	PC5
PA22	PC6
PA23	PC7
PA24	PD0
PA25	PD1
PA26	PD2
PA27	PD3
PA28	PD4
PA29	PD5
PA30	PD6
PA31	PD7
PB00	PE0
PB01	PE1
PB02	PE2
PB03	PE3
PB04	PE4
PB05	PE5
PB06	PE6
PB07	PE7
PB08	PF0
PB09	PF1
PB10	PF2
PB11	PF3
PC00	TOSC1, PG0
PC01	TOSC2, PG1
PC02	XTAL1, PG2

# STK600 Starter Kit

## Target Socket System

Device Pin Name	STK600 Pin Name
PC03	XTAL2, PG3
PC04	PG4
PC05	PG5
PX00	PN2
PX01	PN1
PX02	PN0
PX03	PM7
PX04	PM6
PX05	PM5
PX06	PM4
PX07	PM3
PX08	PM2
PX09	PM1
PX10	PM0
PX11	PP7
PX12	PP5
PX13	PP4
PX14	PP1
PX15	PL3
PX16	PL2
PX17	PL1
PX18	PL0
PX19	PK7
PX20	PK6
PX21	PK5
PX22	PK4
PX23	PK3
PX24	PK2
PX25	PK1
PX26	PK0
PX27	PJ7
PX28	PJ6



# STK600 Starter Kit

## Target Socket System

Device Pin Name	STK600 Pin Name
PX29	PJ5
PX30	PJ4
PX31	PJ3
PX32	PJ2
PX33	PJ1
PX34	PJ0
PX35	PN7
PX36	PN6
PX37	PN5
PX38	PN4
PX39	PN3
PX40	PH0
PX41	PH1
PX42	PH2
PX43	PH3
PX44	PH4
PX45	PH5
PX46	PH6
PX47	PH7
PX48	PL7
PX49	PQ1
PX50	PQ2
PX51	PQ3
PX52	PP3
PX53	PP2
PX54	PP6
PX55	PL6
PX56	PL5
PX57	PL4
PX58	PP0
PX59	PQ5
RESET_N	RESET

# STK600 Starter Kit

## Target Socket System

Device Pin Name	STK600 Pin Name
TCK	TCK
TDI	TDI
TDO	TDO
TMS	TMS
USB_VBUS	VBUST
DN	DN
DP	DP
FSDM	DN
FSDP	DP
GND	GND
VDDANA	VTG
VDDCORE	
VDDIN	VTG

### STK600-RCUC3A144-33

Device Pin Name	STK600 Pin Name
PA00	PA0
PA01	PA1
PA02	PA2
PA03	PA3
PA04	PA4
PA05	PA5
PA06	PA6
PA07	PA7
PA08	PB0
PA09	PB1
PA10	PB2
PA11	PB3, MISO
PA12	PB4, MOSI
PA13	PB5, SCK
PA14	PB6
PA15	PB7

# STK600 Starter Kit

## Target Socket System

Device Pin Name	STK600 Pin Name
PA16	PC0
PA17	PC1
PA18	PC2
PA19	PC3
PA20	PC4
PA21	PC5
PA22	PC6
PA23	PC7
PA24	PD0
PA25	PD1, PP0
PA26	PD2, PL4
PA27	PD3, PL5
PA28	PD4, PL6
PA29	PD5
PA30	PD6
PB00	PE0
PB01	PE1
PB02	PE2
PB03	PE3
PB04	PE4, PP3
PB05	PE5
PB06	PE6
PB07	PE7
PB08	PF0
PB09	PF1
PB10	PF2
PB11	PF3
PB12	PF4
PB13	PF5
PB14	PF6
PB15	PF7
PB16	PG0

# STK600 Starter Kit

## Target Socket System

Device Pin Name	STK600 Pin Name
PB17	PG1, UVCON, PL7
PB18	PG2
PB19	PG3
PB20	PG4
PB21	PG5
PB22	PG6
PB23	PG7
PB24	PH0
PB25	PH1
PB26	PH2
PB27	PH3
PB28	PH4
PB29	PH5, PP2
PB30	PH6
PB31	PH7, PP6
PC00	TOSC1
PC01	TOSC2
PC02	XTAL1
PC03	XTAL2
PC04	
PC05	
PX00	PJ0
PX01	PJ1
PX02	PJ2
PX03	PJ3
PX04	PJ4
PX05	PJ5
PX06	PJ6
PX07	PJ7
PX08	PK0
PX09	PK1
PX10	PK2

# STK600 Starter Kit

## Target Socket System

Device Pin Name	STK600 Pin Name
PX11	PK3
PX12	PK4
PX13	PK5
PX14	PK6
PX15	PK7
PX16	PL0
PX17	PL1
PX18	PL2
PX19	PL3
PX20	PM0
PX21	PM1
PX22	PM2
PX23	PM3
PX24	PM4
PX25	PM5
PX26	PM6
PX27	PM7
PX28	PN0
PX29	PN1
PX30	PN2
PX31	PN3
PX32	PN4
PX33	PN5
PX34	PN6
PX35	PN7
PX36	PP1
PX37	PP4
PX38	PP5
PX39	PP7
RESET_N	RESET
TCK	TCK
TDI	TDI

# STK600 Starter Kit

## Target Socket System

Device Pin Name	STK600 Pin Name
TDO	TDO
TMS	TMS
VBUS	VBUST
ADVREF	AREF0
DM	DN
DP	DP
VDDANA	VTG
VDDCORE	
VDDIN	VTG
GND	GND

### STK600-RCUC3L0-34

Device Pin Name	STK600 Pin Name
PA00	PA0, TCK
PA01	PA1, TMS
PA02	PA2, TDO
PA03	PA3, TDI
PA04	PA4
PA05	PA5
PA06	PA6
PA07	PA7
PA08	PB0, XTAL1
PA09	PB1, XTAL2
PA10	PB2, PH1
PA11	PB3
PA12	PB4
PA13	PB5, PH3
PA14	PB6
PA15	PB7
PA16	PC0
PA17	PC1
PA18	PC2

# STK600 Starter Kit

## Target Socket System

Device Pin Name	STK600 Pin Name
PA19	PC3
PA20	PC4
PA21	PC5
PA22	PC6
PB00	PD0
PB01	PD1
PB02	PD2
PB03	PD3
PB04	PD4
PB05	PD5
PB06	PD6
PB07	PD7
PB08	PE0
PB09	PE1
PB10	PE2
PB11	PE3
PB12	PE4
RESET	MISO, RESET
ADVREFP	AREF0
VDDIN	VTG
VDDCORE	
VDDIO	VTG
VDDANA	
GNDANA	GND
VTG	VTG
GND	GND

### STK600-RCUC3C0-36

Device Pin Name	STK600 Pin Name
PA00	PA0, TCK
PA01	PA1, TDI
PA02	PA2, TDO

# STK600 Starter Kit

## Target Socket System

Device Pin Name	STK600 Pin Name
PA03	PA3, TMS
PA04	PA4
PA05	PA5
PA06	PA6
PA07	PA7
PA08	PB0
PA09	PB1
PA10	PB2
PA11	PB3, AREF1
PA12	PB4
PA13	PB5
PA14	PB6
PA15	PB7
PA16	PC0, AREF0
PA17	PC1
PA18	PC2
PA19	PC3
PA20	PC4
PA21	PC5
PA22	PC6
PA23	PC7
PA24	PD0
PA25	PD1
PA26	PD2
PA27	PD3
PA28	PD4
PA29	PD5
PB00	PE0, TOSC1
PB01	PE1, TOSC2
PB02	PE2
PB03	PE3
PB04	PE4



# STK600 Starter Kit

## Target Socket System

Device Pin Name	STK600 Pin Name
PB05	PE5
PB06	PE6
PB07	PE7
PB08	PF0
PB09	PF1
PB10	PF2
PB11	PF3
PB12	PF4
PB13	PF5
PB14	PF6
PB15	PF7
PB16	PG0
PB17	PG1
PB18	PG2
PB19	PG3
PB20	PG4
PB21	PG5
PB22	PG6
PB23	PG7
PB24	PH0
PB25	PH1
PB26	PH2
PB27	PH3
PB28	PH4
PB29	PH5
PB30	PH6, XTAL1
PB31	PH7, XTAL2
PC00	PJ0
PC01	PJ1, UVCON
PC02	PJ2
PC03	PJ3
PC04	PJ4

# STK600 Starter Kit

## Target Socket System

Device Pin Name	STK600 Pin Name
PC05	PJ5
PC06	PJ6
PC07	PJ7
PC08	PK0
PC09	PK1
PC10	PK2
PC11	PK3
PC12	PK4
PC13	PK5
PC14	PK6
PC15	PK7
PC16	PL0
PC17	PL1
PC18	PL2
PC19	PL3
PC20	PL4
PC21	PL5
PC22	PL6
PC23	PL7
PC24	PM0
PC25	PM1
PC26	PM2
PC27	PM3
PC28	PM4
PC29	PM5
PC30	PM6
PC31	PM7
PD00	PN0
PD01	PN1
PD02	PN2
PD03	PN3
PD04	PN4

# STK600 Starter Kit

## Target Socket System

Device Pin Name	STK600 Pin Name
PD05	PN5
PD06	PN6
PD07	PN7
PD08	PP0
PD09	PP1
PD10	PP2
PD11	PP3
PD12	PP4
PD13	PP5
PD14	PP6
PD15	PP7
PD16	PQ0
PD17	PQ1
PD18	PQ2
PD19	PQ3
PD20	PQ4
PD21	PQ5
PD22	PQ6
PD23	PQ7
PD24	PDATA0
PD25	PDATA1
PD26	PDATA2
PD27	PDATA3
PD28	PDATA4
PD29	PDATA5
PD30	PDATA6
RESET	MISO, RESET
VBUS	VBUST
DM	DN
DP	DP
VDDANA	VTG
VDDCORE	

# STK600 Starter Kit

## Target Socket System

Device Pin Name	STK600 Pin Name
VDDIN	VTG
GND	GND

### STK600-RCUC3C1-38

Device Pin Name	STK600 Pin Name
PA00	PA0, TCK
PA01	PA1, TDI
PA02	PA2, TDO
PA03	PA3, TMS
PA04	PA4
PA05	PA5
PA06	PA6
PA07	PA7
PA08	PB0
PA09	PB1
PA10	PB2
PA11	PB3, AREF1
PA12	PB4
PA13	PB5
PA14	PB6
PA15	PB7
PA16	PC0, AREF0
PA17	PC1
PA18	PC2
PA19	PC3
PA20	PC4
PA21	PC5
PA22	PC6
PA23	PC7
PA24	PD0
PA25	PD1
PB00	PE0, TOSC1

# STK600 Starter Kit

## Target Socket System

Device Pin Name	STK600 Pin Name
PB01	PE1, TOSC2
PB02	PE2
PB03	PE3
PB04	PE4
PB05	PE5
PB06	PE6
PB19	PG3
PB20	PG4
PB21	PG5
PB22	PG6
PB23	PG7
PB30	PH6, XTAL1
PB31	PH7, XTAL2
PC00	PJ0
PC01	PJ1, UVCON
PC02	PJ2
PC03	PJ3
PC04	PJ4
PC05	PJ5
PC06	PJ6
PC07	PJ7
PC11	PK3
PC12	PK4
PC13	PK5
PC14	PK6
PC15	PK7
PC16	PL0
PC17	PL1
PC18	PL2
PC19	PL3
PC20	PL4
PC21	PL5

# STK600 Starter Kit

## Target Socket System

Device Pin Name	STK600 Pin Name
PC22	PL6
PC23	PL7
PC24	PM0
PC31	PM7
PD00	PN0
PD01	PN1
PD02	PN2
PD03	PN3
PD07	PN7
PD08	PP0
PD09	PP1
PD10	PP2
PD11	PP3
PD12	PP4
PD13	PP5
PD14	PP6
PD21	PQ5
PD22	PQ6
PD23	PQ7
PD24	PDATA0
PD27	PDATA3
PD28	PDATA4
PD29	PDATA5
PD30	PDATA6
RESET	MISO, RESET
VBUS	VBUST
DM	DN
DP	DP
VDDANA	VTG
VDDCORE	
VDDIN	VTG
GND	GND

# STK600 Starter Kit

## Target Socket System

STK600-RCUC3C2-40

Device Pin Name	STK600 Pin Name
PA00	PA0, TCK
PA01	PA1, TDI
PA02	PA2, TDO
PA03	PA3, TMS
PA04	PA4
PA05	PA5
PA06	PA6
PA07	PA7
PA08	PB0
PA09	PB1
PA16	PC0, AREF0
PA17	PC1
PA18	PC2
PA19	PC3
PA20	PC4
PA21	PC5
PA22	PC6
PA23	PC7
PB00	PE0, TOSC1
PB01	PE1, TOSC2
PB30	PH6, XTAL1
PB31	PH7, XTAL2
PC02	PJ2
PC03	PJ3
PC04	PJ4
PC05	PJ5
PC15	PK7
PC16	PL0
PC17	PL1
PC18	PL2
PC19	PL3

# STK600 Starter Kit

## Target Socket System

Device Pin Name	STK600 Pin Name
PC20	PL4
PC21	PL5
PC22	PL6
PD00	PN0
PD01	PN1
PD02	PN2
PD03	PN3
PD11	PP3
PD12	PP4, UVCON
PD13	PP5
PD14	PP6
PD21	PQ5
PD27	PDATA3
PD28	PDATA4
PD29	PDATA5
PD30	PDATA6
RESET	MISO, RESET
VBUS	VBUST
DM	DN
DP	DP
VDDANA	VTG
VDDCORE	
VDDIN	VTG
GND	GND

### STK600-RCUC3L3U-47

Device Pin Name	STK600 Pin Name
PA00	TCK, PA0
PA01	PA1, TMS
PA02	PA2, TDO
PA03	PA3, TDI
PA04	PA4



# STK600 Starter Kit

## Target Socket System

Device Pin Name	STK600 Pin Name
PA05	PA5
PA06	PA6
PA07	PA7
PA08	PB0, XTAL1
PA09	PB1, XTAL2
PA10	PB2, PH1
PA11	PB3
PA12	PB4
PA13	PB5, PH3
PA14	PB6
PA15	PB7
PA16	PC0
PA17	PC1
PA18	PC2
PA19	PC3
PA20	PC4
PA21	PC5
PA22	PC6
PB00	PD0
PB01	PD1
PB02	PD2
PB03	PD3
PB04	PD4
PB05	PD5
PB06	PD6
PB07	PD7
PB08	PE0
PB09	PE1
PB10	PE2
PB11	PE3
PB12	PE4
PB13	PE5, DN

# STK600 Starter Kit

## Target Socket System

Device Pin Name	STK600 Pin Name
PB14	PE6, DP
PB15	PE7
PB16	PF0
PB17	PF1
PB18	PF2
PB19	PF3
PB20	PF4
PB21	PF5
PB22	PF6
PB23	PF7
PB24	PG0
PB25	PG1
PB26	PG2
PB27	PG3
RESET	MISO, RESET
VDDANA	
ADVREFP	AREF0
VDDIN	VTG
VDDIO	VTG
GND	GND

### STK600-RCUC3D3-48

Device Pin Name	STK600 Pin Name
PA0	PA0, TDI
PA10	PB2
PA11	PB3, TOSC1
PA12	PB4, TOSC2
PA13	PB5
PA14	PB6
PA15	PB7
PA16	PC0
PA17	PC1

# STK600 Starter Kit

## Target Socket System

Device Pin Name	STK600 Pin Name
PA18	PC2, XTAL1
PA19	PC3, XTAL2
PA1	PA1, TDO
PA20	PC4
PA21	PC5
PA22	PC6
PA23	PC7
PA24	PD0
PA25	PD1
PA26	PD2
PA27	PD3
PA28	PD4
PA29	PD5
PA2	PA2, TMS
PA30	PD6
PA31	PD7
PA3	PA3
PA4	PA4
PA5	PA5
PA6	PA6
PA7	PA7
PA8	PB0
PA9	PB1
PB0	PE0
PB10	PF2
PB11	PF3
PB12	PF4, TCK
PB13	PF5
PB14	PF6
PB15	PF7
PB16	PG0, VBUST
PB17	PG1

# STK600 Starter Kit

## Target Socket System

Device Pin Name	STK600 Pin Name
PB18	PG2
PB1	PE1
PB2	PE2
PB3	PE3
PB4	PE4
PB5	PE5
PB6	PE6
PB7	PE7
PB8	PF0
PB9	PF1
RESET	MISO, RESET
AREF0	AREF0
DN	DN
DP	DP
VDDANA	VTG
VDDCORE	
VDDIN	VTG
VDDOUT	
GND	GND

### STK600-RCUC3D4-49

Device Pin Name	STK600 Pin Name
PA00	PA0, TDI
PA01	PA1, TDO
PA02	PA2, TMS
PA03	PA3
PA04	PA4
PA05	PA5
PA06	PA6
PA07	PA7
PA08	PB0
PA09	PB1

# STK600 Starter Kit

## Target Socket System

Device Pin Name	STK600 Pin Name
PA10	PB2
PA11	PB3, TOSC1
PA12	PB4, TOSC2
PA13	PB5
PA14	PB6
PA15	PB7
PA16	PC0
PA17	PC1
PA18	PC2, XTAL1
PA19	PC3, XTAL2
PA20	PC4
PA21	PC5
PA22	PC6
PA23	PC7
PA24	PD0
PA25	PD1
PA26	PD2
PA27	PD3
PB12	PF4, TCK
PB13	PF5
PB14	PF6
PB15	PF7
PB16	PG0, VBUST
PB17	PG1
PB18	PG2
RESET	MISO, RESET
AREF0	AREF0
DN	DN
DP	DP
VDDANA	VTG
VDDCORE	
VDDIN	VTG

# STK600 Starter Kit

## Target Socket System

Device Pin Name	STK600 Pin Name
VDDOUT	
GND	GND

### STK600-RCUC3L4U-53

Device Pin Name	STK600 Pin Name
PA00	PA0, TCK
PA01	PA1, TMS
PA02	PA2, TDO
PA03	PA3, TDI
PA04	PA4
PA05	PA5
PA06	PA6, VBUST
PA08	PB0, XTAL1
PA09	PB1, XTAL2
PA10	PB2, PH1
PA11	PB3
PA12	PB4
PA13	PB5, PH3
PA14	PB6
PA15	PB7
PA16	PC0
PA17	PC1
PA18	PC2
PA19	PC3
PA20	PC4
PA21	PC5
PA22	PC6
PB00	PD0
PB02	PD2
PB03	PD3
PB04	PD4
PB05	PD5

Device Pin Name	STK600 Pin Name
PB06	PD6
PB07	PD7
PB08	PE0
PB09	PE1
PB10	PE2
PB11	PE3
PB12	PE4
PB13	PA7, PE5, DN
PB14	PD1, PE6, DP
RESET	MISO, RESET
VDDIO	VTG
GND	GND

### 5.7 SAM Routing Cards

To allow SAM D20J devices to connect to the STK600, a special RC064SAM-72 routing card has been made. This breaks out the pins to the pins on the STK600.

**Note:** The STK600 itself cannot communicate with the SAM device, as the STK600 does not support SWD or the JTAG commands needed for SAM devices.





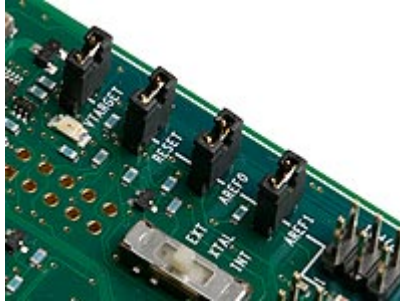

### 6.2.1 On-board VTG Source

The on-board VTG source is set from Atmel Studio. To use this source, the VTARGET jumper must be mounted. The on-board supply can be adjusted from 0.9 to 5.5V in steps of 0.1V.

VTG can also be set to 0V, but due to hardware limitations, the on-board generated VTG cannot be set between 0 and 0.9V.

**Note:** Always check the AVR device data sheet for operating voltage range before adjusting VTG.

See the help section for the Atmel Studio Programming Dialog for information on how to adjust VTARGET.

#### 6.2.1.1 Powering STK600 from USB

When the STK600 is powered through the USB cable, approximately 300 mA can be delivered to the target section.

#### 6.2.1.2 Powering STK600 from an External DC Source

If an external DC jack input is used, approximately 1A can be delivered to the target section.

### 6.2.2 External VTG

If the VTARGET jumper is removed, the VTG must be supplied from an external source. Connect the external source to one of the VTG pins on any of the PORT headers. Always connect common ground (GND) when using an external VTG voltage.

When using an external source, the user must ensure that the VTG is higher than any of the AREF voltages.

**Note:**

The kit must always be powered when using an external VTARGET supply. If the VTG voltage is supplied from an external source while the main power switch is in the OFF position the kit may become damaged.

### 6.2.3 Status LEDs

#### 6.2.3.1 VTARGET LED

A green LED next to the VTARGET jumper will be lit when there is a voltage of 0.9V or higher available on the VTG net.

#### 6.2.3.2 STK600 Status LED

If a short circuit is detected when using the on-board VTG supply, the STK600 status LED will blink red.

## 6.3 Analog Reference Voltages

The A/D converter of the AVR device needs a reference voltage to set its converting range. STK600 can supply two of these voltages; AREF0 and AREF1.

# STK600 Starter Kit

## Hardware Description

For all tinyAVR and megaAVR devices, only the AREF0 is connected through the routing card, for AVR XMEGA devices, AREF0 is connected to AREFA and AREF1 is connected to AREFB.

For AVR XMEGA devices the AREF pins are also general purpose I/O pins. Hence, to use the pins as GPIO the AREF jumpers must be removed.

**Note:** For routing card “STK600-RC100X-13” revision A and revision B the AREF1 is connected to PA1. These cards are marked “A0607.3.1213.A” and “A0607.3.1213.B”.



If the AREF0/AREF1 jumpers are mounted, the on-board Analog Reference Voltage sources are connected to the target AREF pins of the AVR device. The on-board Analog Reference Voltages can be adjusted from the PC software in the range 0 to 5.5V, but not above VTARGET. The resolution and accuracy is 10 mV.

The AREF0 and AREF1 generated voltages can also be connected to the analog comparator.

The target AREF signals of the AVR device are accessible on the AUX header. The figure below shows the connection of the AREF signals, the target section, and the AREF sources.

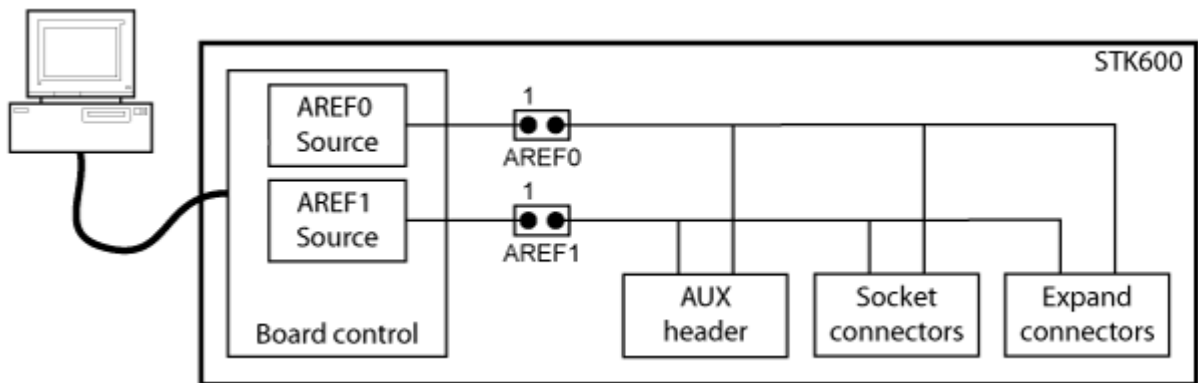

### 6.3.1 Using External Voltage Reference

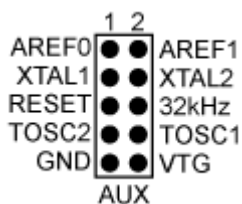

When the AREF0/AREF1 jumper is disconnected, the ADC reference voltage can be supplied from an external source, by connecting to the AREF0/AREF pins on the AUX header.

When using an external source for AREF, VTARGET must be controlled at a higher voltage level than AREF. This can easily be controlled by reading the VTG value from the programming dialog in Atmel Studio before setting AREF.

**Note:** The AREF0 and AREF1 voltages, which are visible in the PC software, are the STK600 generated voltages. Externally applied AREF voltages cannot be read from Atmel Studio.

### 6.3.2 Using the Internal Voltage Reference

If the internal voltage reference of the AVR device is used, the AREF0/AREF1 jumper must be removed.

### 6.3.3 Using AREF as Analog Input

AREF0 and AREF1 can also be used as analog inputs to any of the ADC channels.

For tinyAVR and megaAVR devices, where only AREF0 is connected to the device via the routing card, AREF1 can be connected to an ADC channel by connecting a cable from AREF1 on the AUX header and to the port pin header corresponding to the ADC channel. (Check the device data sheet for which port pin header to connect to.)

If the AVR device's internal voltage reference or an external voltage reference is used, the AREF0/AREF1 jumper must be removed. If this is the case, AREF0 or AREF1 can be used as analog inputs by connecting a cable from pin 1 on the AREF0/AREF1 header to the port pin header corresponding to the ADC channel.

### 6.3.4 AREF Decoupling Capacitor

The routing card has a decoupling capacitor on AREF. This is marked with silk print on the PCB. For some AVR devices, the AREF pin is on a pin which also is part of the high-voltage programming interface. On these routing cards, the AREF capacitor is not mounted, as it would make it impossible to use the high-voltage programming interface. A capacitor can be soldered to achieve better noise performance. A typical value is 10 nF. The footprint for the capacitor is SMD size 0603.

### 6.3.5 Short Circuit Protection

The internal AREF voltage generators have a short circuit protection. If the STK600 measures the AREF0/AREF1 to be 0.3V or more below the set-point, AREF will be shut off. When this happens, the status LED will blink red. The AREF0 and AREF1 will also be shut down by the Master MCU if a short circuit is detected on VTarget (in addition to shutting down VTarget). In this case, the status LED will blink red.

## 6.4 RESET Control

The STK600 controls the RESET signal to the target AVR device. Under normal operation, the RESET line is held in an inactive high state (pull-up to VTG).

### 6.4.1 The RESET Jumper



The RESET jumper connects the RESET pin on the target AVR device to the STK600. When the RESET jumper is mounted, the STK600 controls the RESET signal. When the RESET jumper is not mounted, the RESET signal is disconnected. This latter is useful for prototyping applications with an external reset system.

The RESET jumper must always be mounted when high-voltage programming an AVR device. If using an external reset system, it must allow the reset line to be controlled by the STK600 during programming.

### 6.4.2 The RESET Button

STK600 has a reset button that resets the target AVR device when being pushed. The button has no function if the RESET jumper is not mounted.

### 6.4.3 RESET Signal on AUX Header

The target RESET signal of the AVR device is accessible on the AUX header. This pin can be used to apply an external RESET signal. When applying an external reset signal, the reset jumper must be removed.

### 6.4.4 12V Programming Voltage

During high-voltage programming, STK600 applies 12V to the RESET line of the AVR device. Thus, an external reset circuit not capable of handling this must be disconnected before high-voltage programming the AVR device.

### 6.4.5 External RESET Decoupling

When connected to an external system, there is often an external pull-up resistor and a capacitor connected to the reset line. A typical reset connection is shown below.

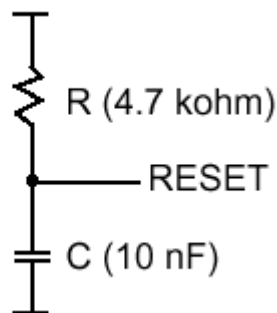

If the external pull-up resistor is too strong (i.e.,  $\ll 4.7 \text{ k}\Omega$ ), STK600 may not be able to pull the RESET line low.

See also [7.9.1 Reset Line](#) when programming an external target.

## 6.5 Port Connectors

All I/O port pins on the target AVR device mounted on the STK600 are available on port pin connectors. These are labeled PORTA, PORTB, PORTC, etc.

Depending on the AVR device in use, different ports will be available.

The picture below shows PORTA. Here, all port pins PA0 to PA7 are available, in addition to the target voltage VTG and GND.

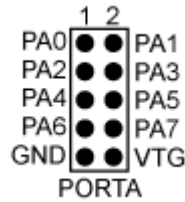

The other port connectors are identical, only with different signal names.

Cables can be mounted between the port connectors and the other peripherals on the board, or to external hardware.

### 6.5.1 AUX Port Connector

The AUX connector is located in the port connector area. The figure below shows the pinout for the connector.

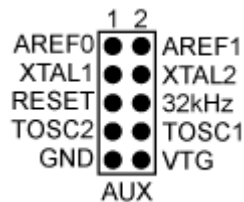

The signals, which are described in the below sections, are available.

#### 6.5.1.1 AREF0

Analog Reference voltage. This pin is connected to the AREF pin on devices having a single separate analog reference pin. For devices with two AREF pins, this pin is connected to the AREF+ pin. The AREF0 voltage is controlled from the PC software if the AREF0 jumper is mounted.

#### 6.5.1.2 AREF1

Analog Reference voltage. This pin is connected to the AREF- pin on devices having two separate analog reference pins. The AREF1 voltage is controlled from the PC software if the AREF1 jumper is mounted.

#### 6.5.1.3 XTAL1

The XTAL1 signal on the AVR device is routed to this pin. If the CLOCK switch is set to the INT position, this pin can be used to apply an external clock signal.

#### 6.5.1.4 XTAL2

The XTAL2 pin on the AVR device. If the CLOCK switch is set to the INT position, this pin can be used for an external crystal with the XTAL1 pin.

#### 6.5.1.5 RESET

The RESET pin on the AVR device is available on this pin.

#### 6.5.1.6 32 KHz

A 32 KHz clock signal is available on this pin. It can be connected to a device's TOSC1 pin in order to implement a real-time clock. Place a jumper between the 32 KHz pin and the neighboring TOSC1 pin.

#### 6.5.1.7 TOSC2 and TOSC1

For AVR devices with a timer that can be clocked from an external low-frequency crystal, these two pins are available. The TOSC1 pin can easily be connected to the AUX port's 32 KHz pin (32 KHz clock signal) by a jumper.

### 6.6 LEDs and Switches

STK600 has eight LEDs and eight switches that can be connected to I/O pins on the AVR device. The LEDS and SWITCHES connectors are found in the port connector area.

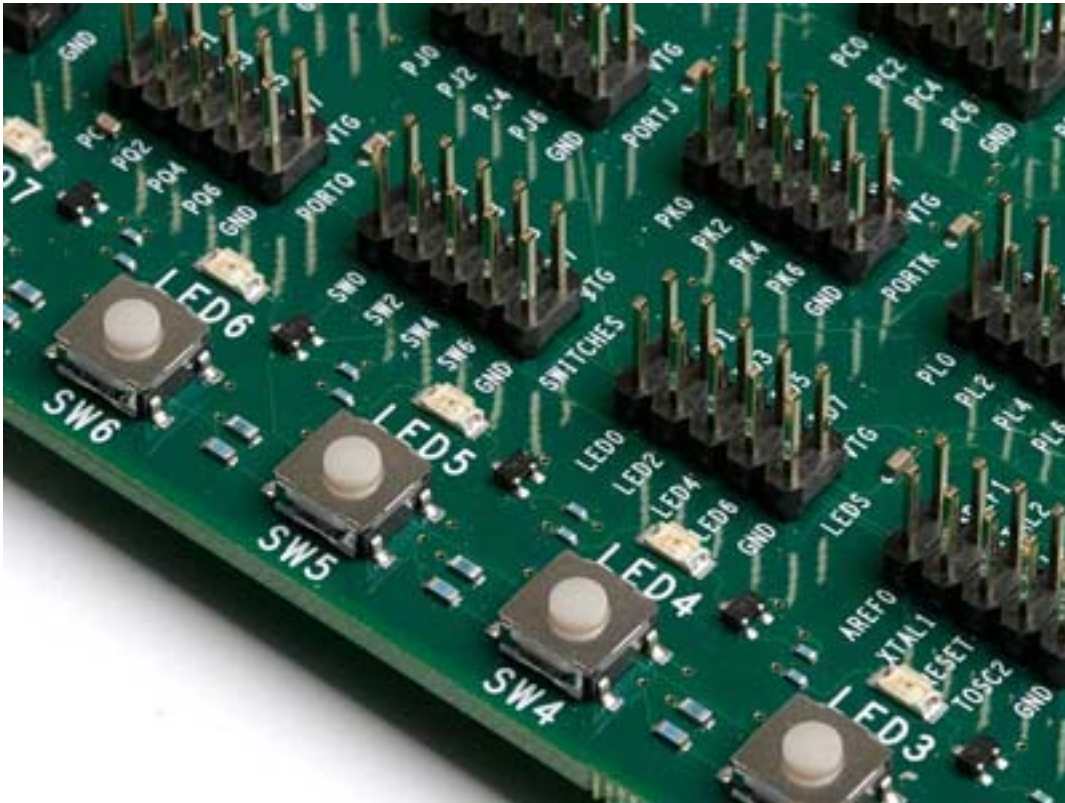

#### 6.6.1 LEDs

The LEDs are labeled LED0 to LED7. The corresponding pins on the LEDS header have the same labels.

The LED hardware is shown in the figure below. The transistor circuit ensures the LED brightness is independent of the target voltage.

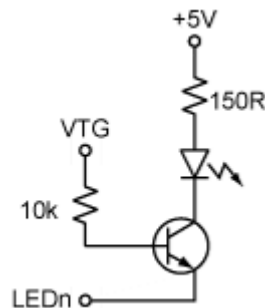

To light one of the LEDs, the corresponding pin found on the LEDs header must be pulled to GND.

To control the LEDs from the AVR device, connect a cable between the LEDS header and one of the PORT headers. Use a 10-wire cable to connect to all eight LEDs or a two-wire cable to control one or two LEDs.

Just like the PORT headers, the LEDS header has GND and VTG on pin 9 and 10. When using a 10-wire cable, make sure the pin one indication on the cable (red wire with a triangular arrow pointing on pin one) aligns to pin 1 on both the LEDS header and PORT pin header.

The I/O port connected to LEDn will not source any significant current when LEDn is driven high, but it will sink a current of approximately 18 mA when LEDn is pulled to GND.

### 6.6.2 Switches

The switches are labeled SW0 to SW7 and are available on the SWITCHES header. The switch hardware is shown below:

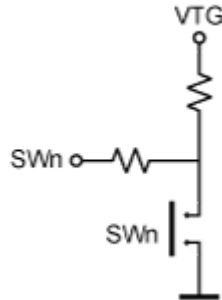

When pressing one of the switches, the corresponding SW pin on the SWITCHES header will be pulled low. When the switch is released, the switch's 10 kΩ pull-up will pull the line to VTG. The 150Ω resistor prevents a large current to flow to ground in case of wrong wiring.

Connect a cable between the SWITCHES header and one of the PORT headers. Use a 10-wire cable to connect to all eight switches or a two-wire cable to connect to one or two switches.

**Note:** On most AVR device pins configured as input, you can enable an internal pull-up, removing the need for an external pull-up on the push button. In the STK600 design, an external 10 kΩ pull-up is present to give all users a logical '1' on SWn when the push button is not pressed, even if the internal pull-up is not enabled.

## 6.7 Clock Settings

STK600 includes several clock options for the target AVR device.

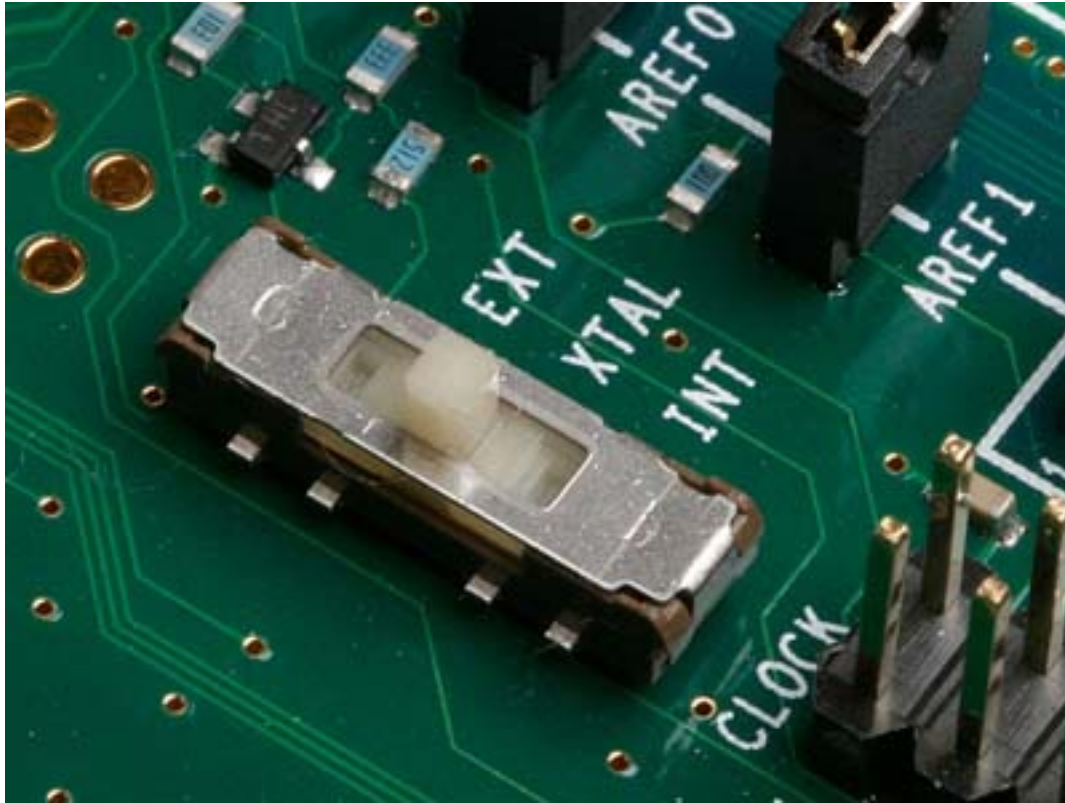

A switch selects between the following three options:

- Programmable clock generator
- Crystal oscillator (with a socket for a crystal)
- XTAL1 Pin tri-stated (to be used with the AVR device's internal RC oscillator)

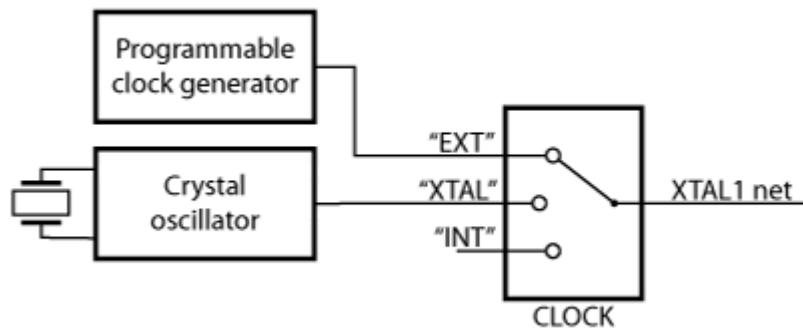

### 6.7.1 Programmable Clock Generator

The programmable clock generator is set from the PC software. The frequency can be set from 1.1 kHz to 66 MHz with 0.5% accuracy.

To use the programmable clock generator as a clock source, set the CLOCK switch to EXT position.

### 6.7.2 Crystal Oscillator

The on-board crystal oscillator will work with ceramic resonators or crystals between 4 and 24MHz (AT-cut, fundamental, and parallel resonant crystals). Place a crystal in the crystal socket (located next to the PROGRAM button).



To use the crystal oscillator as a clock source, set the CLOCK switch to the XTAL position.

### 6.7.3 XTAL1 Pin Tri-stated

If the target AVR device runs on the internal oscillator, the XTAL1 pin can be disconnected from the clock sources on STK600.

To disconnect the XTAL1 pin, set the CLOCK switch to the INT position.

### 6.7.4 Real-Time Clock

The STK600 also features a 32768 Hz oscillator, which can be used to make a real-time clock. The output from the oscillator is available on the 32 KHz pin on the AUX header. This clock can be routed to the TOSC1 pin on the target AVR device by placing a jumper between the 32 KHz and TOSC1 pin on the AUX header.

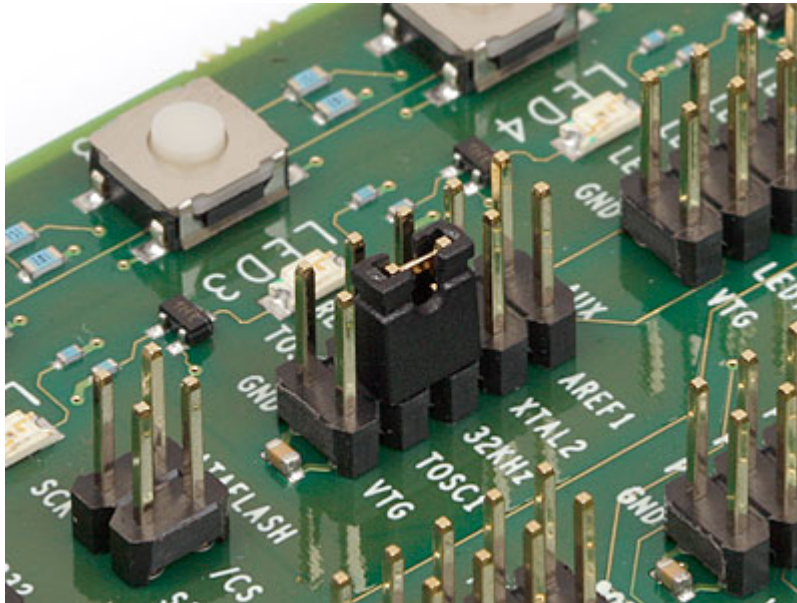

See also [6.5 Port Connectors](#) for more information about the AUX header.

### 6.7.5 Other Considerations

#### 6.7.5.1 High-Voltage Programming

When programming the target AVR device in High-Voltage Programming mode, the clock settings are overridden and the device is clocked directly from the STK600 controller. The clock selection switch can be set to any position.

#### 6.7.5.2 On-chip Crystal Oscillator

In a real-life application where the crystal can be placed close to the AVR device's XTAL1 and XTAL2 pins, there is no need for an external oscillator circuit. The long clock signal lines and socket system connectors on STK600 makes it difficult to drive a crystal with the on-chip oscillators. This is resolved by having a crystal oscillator on STK600. The oscillator is designed to operate over the full target voltage range.

#### 6.7.5.3 Shared XTAL1/Port Pin

Some AVR devices have an XTAL1 pin, which can also be used as a regular I/O port pin. The routing card for these devices will connect the device pin to both the XTAL1 net and a port pin header on the STK600. Hence, to use the pin as an I/O port the clock selection switch must be set to position INT to disconnect the clock drivers on STK600 from the pin.

### 6.8 User RS-232 Interface

The STK600 includes RS-232 hardware that can be used for communication between the target AVR microcontroller in the socket and a PC serial port. STK600 has a 9-pin DSUB connector that can be connected to a PC with a straight serial cable (not a null modem cable).

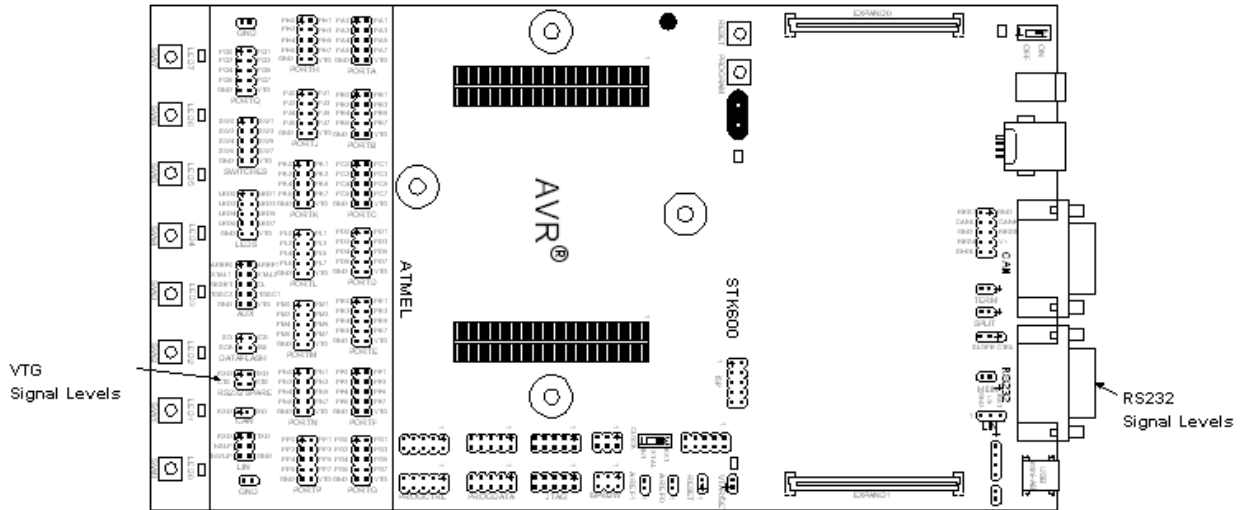

To use the RS-232 interface, the AVR device's UART pins must be connected to the appropriate pins on the "RS-232 SPARE" pin header. Use a 2-wire cable to connect the AVR device's RXD and TXD pins to the pin header. The "RS-232 SPARE" pin header is found in the target header section, while the DSUB marked "RS-232" is located on the other end of the card.

Optionally, one can connect the RTS (Request To Send) and CTS (Clear To Send) signals to two free I/O ports. The RTS and CTS signals are used for flow control. The connection is shown below.

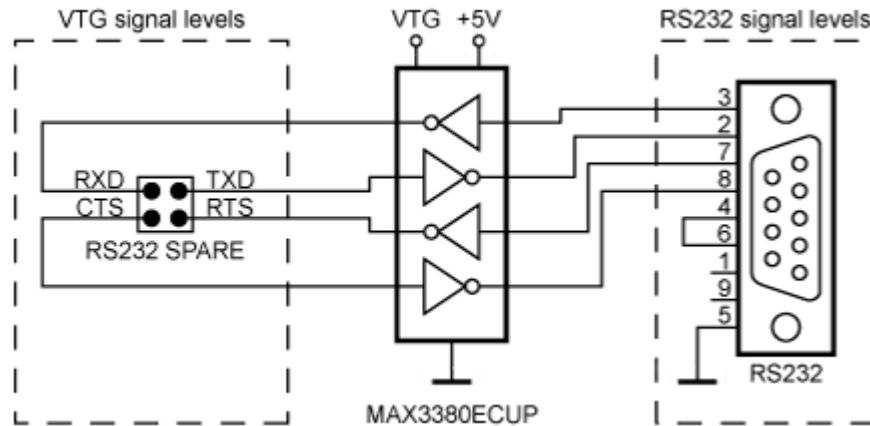

If the RTS and CTS lines are not controlled by the AVR device, a jumper shorting the RTS and CTS pins on the "RS-232 SPARE" header can resolve communication problems, if the PC side expects these handshake lines to be active.

#### 6.8.1 Flow Control and RTS/CTS Signaling

Flow control is used to avoid data loss in transmission when one party is unavailable to receive data. When a DTE (such as a PC) wants to stop the data flow into it, it negates RTS. Read a negated "Request To Send" as "request NOT to send to me" (stop sending). When the PC is ready for more bytes it asserts RTS and the flow of bytes to it can resume. Flow control signals are always sent in a direction opposite to

the flow of bytes that is being controlled. DCE equipment (i.e., AVR) works the same way but sends the stop signal out the CTS pin (negated CTS: “(you are) NOT Cleared To Send”).

### 6.9 DataFlash Nonvolatile Memory

An AT45DB041B 4 Mb DataFlash is included on the STK600 for nonvolatile data storage. This is a high-density Flash memory chip with Serial Peripheral Interface (SPI). A detailed data sheet of the DataFlash can be obtained from the Microchip website.

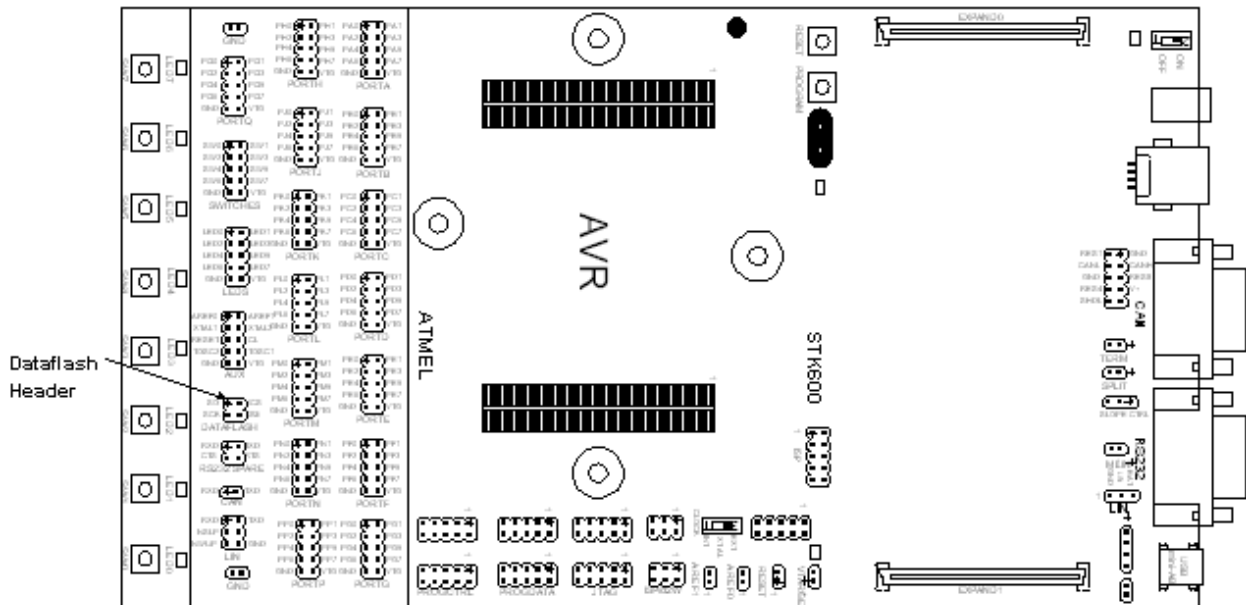

The DataFlash can be connected to the I/O pins of the microcontroller sockets. The 4-pin header marked DATAFLASH can be used for connecting the SPI of the DataFlash to the I/O pins on the target AVR microcontroller in the socket. Two-wire cables are included with STK600 for connecting the DataFlash to the I/O pins. The connection of the I/O pins is shown in the figure below.

The connection of the DataFlash to the AVR device hardware SPI is shown in the block schematic below.

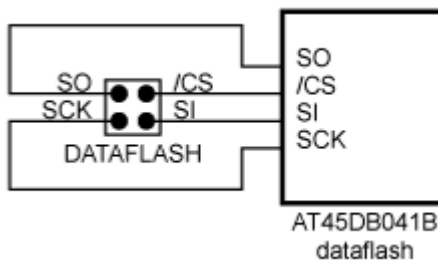

More information about how to use the DataFlash can be found on <http://www.microchip.com/>.

### 6.10 Expansion Connectors

STK600 has two expansion connectors. All AVR device I/O ports, programming signals, and control signals are routed to the expansion connectors. The expansion connectors allow easy prototyping of applications with STK600.

# STK600 Starter Kit

## Hardware Description

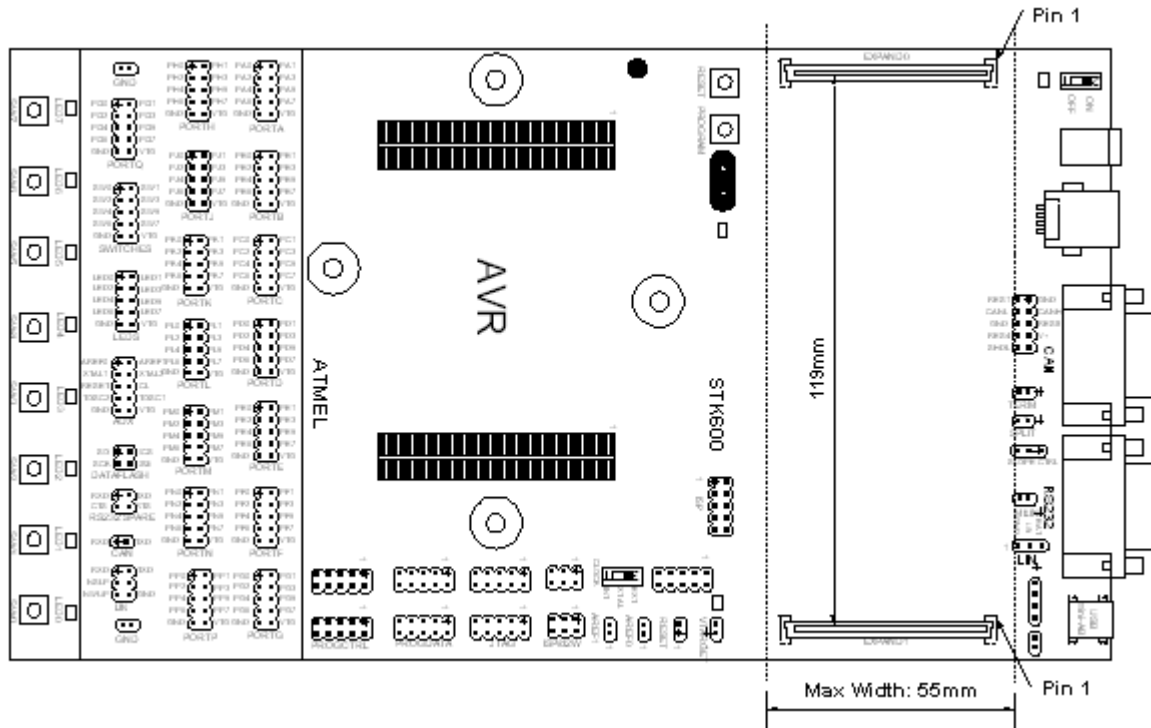

The connectors to be used on an expansion board are manufactured by FCI and have P/N: 61082-101402LF. See also [www.fciconnect.com](http://www.fciconnect.com) for more information.

The connectors must be placed with exactly 119 mm from center to center. The expansion board must have a maximum width of 55 mm to avoid collision with components on the main board.

The pinout of the expansion connectors is shown in the table below.

**Table 6-1. EXPAND Connector Pinout**

EXPAND0				EXPAND1			
GND	1	2	VTG	GND	1	2	VTG
PA0	3	4	PA1	PJ0	3	4	PJ1
PA2	5	6	PA3	PJ2	5	6	PJ3
PA4	7	8	PA5	PJ4	7	8	PJ5
PA6	9	10	PA7	PJ6	9	10	PJ7
GND	11	12	VTG	GND	11	12	VTG
PB0	13	14	PB1	PK0	13	14	PK1
PB2	15	16	PB3	PK2	15	16	PK3
PB4	17	18	PB5	PK4	17	18	PK5
PB6	19	20	PB7	PK6	19	20	PK7
GND	21	22	VTG	GND	21	22	VTG
PC0	23	24	PC1	PL0	23	24	PL1

# STK600 Starter Kit

## Hardware Description

EXPAND0				EXPAND1			
PC2	25	26	PC3	PL2	25	26	PL3
PC4	27	28	PC5	PL4	27	28	PL5
PC6	29	30	PC7	PL6	29	30	PL7
GND	31	32	VTG	GND	31	32	VTG
PD0	33	34	PD1	PM0	33	34	PM1
PD2	35	36	PD3	PM2	35	36	PM3
PD4	37	38	PD5	PM4	37	38	PM5
PD6	39	40	PD7	PM6	39	40	PM7
GND	41	42	VTG	GND	41	42	VTG
PE0	43	44	PE1	PN0	43	44	PN1
PE2	45	46	PE3	PN2	45	46	PN3
PE4	47	48	PE5	PN4	47	48	PN5
PE6	49	50	PE7	PN6	49	50	PN7
GND	51	52	VTG	GND	51	52	VTG
PF0	53	54	PF1	PP0	53	54	PP1
PF2	55	56	PF3	PP2	55	56	PP3
PF4	57	58	PF5	PP4	57	58	PP5
PF6	59	60	PF7	PP6	59	60	PP7
GND	61	62	VTG	GND	61	62	VTG
PG0	63	64	PG1	PQ0	63	64	PQ1
PG2	65	66	PG3	PQ2	65	66	PQ3
PG4	67	68	PG5	PQ4	67	68	PQ5
PG6	69	70	PG7	PQ6	69	70	PQ7
GND	71	72	VTG	GND	71	72	VEXT
PH0	73	74	PH1	GND	73	74	VEXT
PH2	75	76	PH3	VCC	75	76	GND
PH4	77	78	PH5	VCC	77	78	GND
PH6	79	80	PH7	PDATA0	79	80	PDATA1
GND	81	82	VTG	PDATA2	81	82	PDATA3
XTAL1	83	84	AREF0	PDATA4	83	84	PDATA5
XTAL2	85	86	AREF1	PDATA6	85	86	PDATA7
GND	87	88	MOSI	PCTRL0	87	88	PCTRL1

EXPAND0				EXPAND1			
TOSC1	89	90	MISO	PCTRL2	89	90	PCTRL3
TOSC2	91	92	SCK	PCTRL4	91	92	PCTRL5
TGT_RST	93	94	TDI	PCTRL6	93	94	PCTRL7
VCC6	95	96	TDO	GND	95	96	VCC3
GND	97	98	TMS	B_ID0	97	98	B_ID1
VCC6	99	100	TCK	B_ID6	99	100	B_ID7

### 6.11 User USB Connector

STK600 has a USB connector that the target AVR devices with USB interface can utilize. The connector is a Mini-AB connector that supports on-the-go functionality. The routing card for the device connects the USB connector to the appropriate pins on the AVR device.

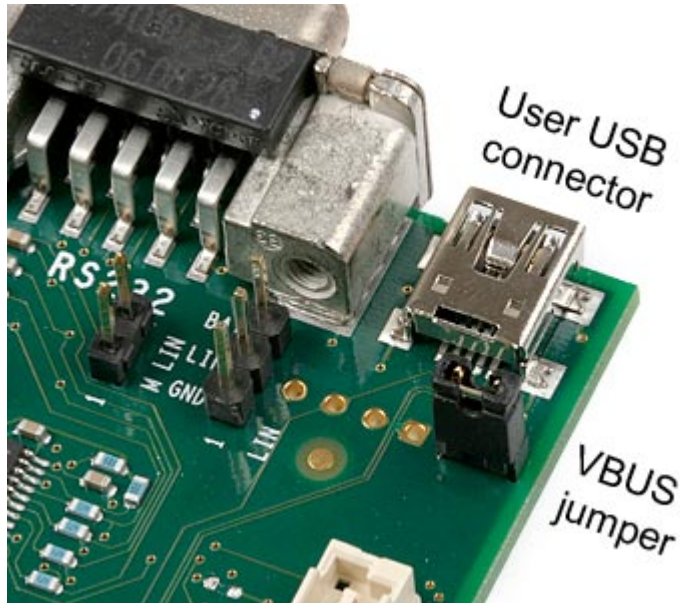

#### 6.11.1 VBUS Generation

When the target AVR device is acting as an on-the-go master it must supply VBUS voltage to the USB device it is controlling. To do so, place a jumper on the pin header (J901) next to the USB connector. The FET is controlled by the UVCON signal, also routed to the target AVR device.

When not using the VBUS generation feature, the jumper must be removed.

**Note:** VCC is 5.3V.

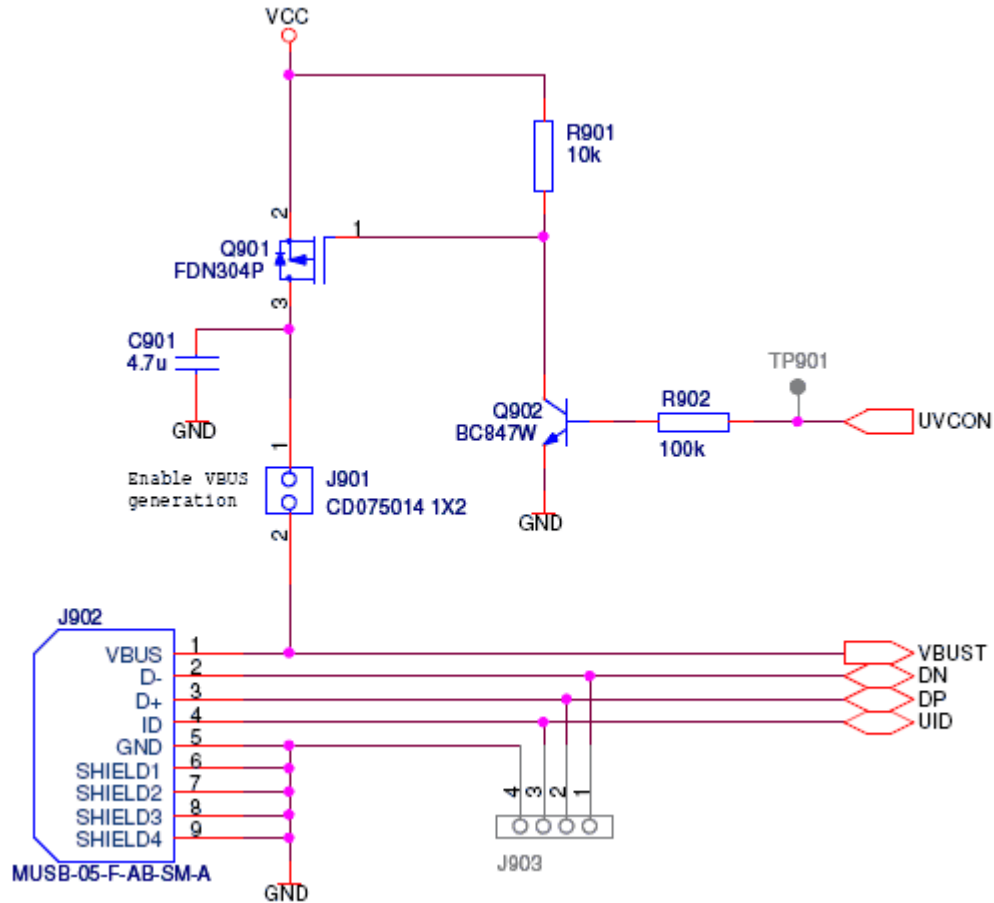

### 6.12 CAN Transceiver

Controller Area Network (CAN) is a broadcast, differential serial bus standard typically used in the automotive industry. The CAN features high immunity to electromechanical noise and arbitration-free fixed priority.

STK600 features the ATA6660 CAN transceiver. A male DB9 connector and a 10-pin header are provided for bus connection.

# STK600 Starter Kit

## Hardware Description

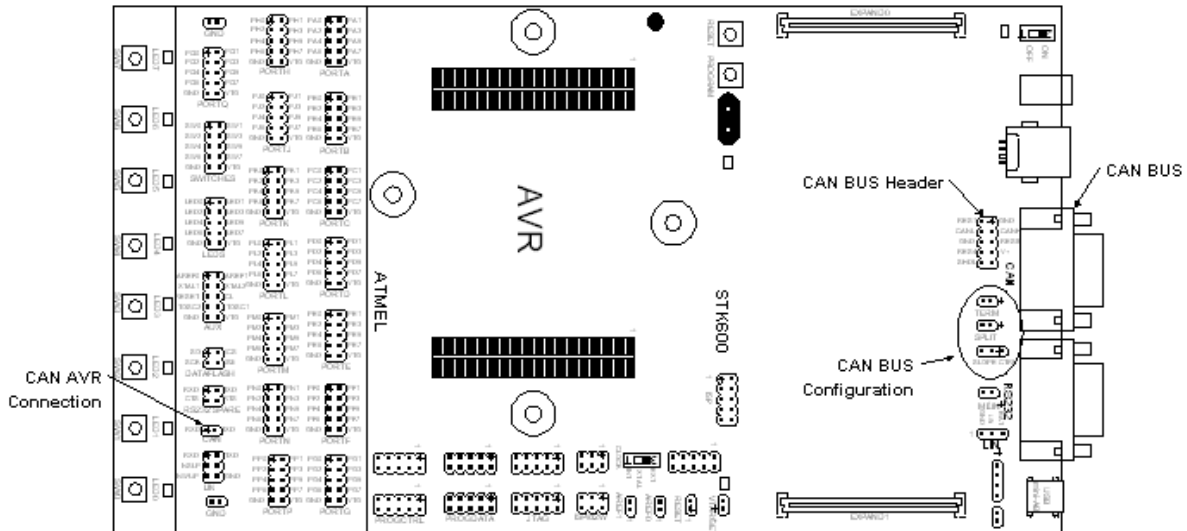

If a network termination is needed (CAN baud rate higher than 100 kbps), the 'TERM' jumper can be mounted to insert a 120Ω resistor between CAN-H and CAN-L.

'SLOPE CTRL' is provided to adjust the CAN signal slopes and prevent unsymmetrical transients on the bus lines. The center pin on 'SLOPE CTRL' is connected to the ATA6660 RS pin. This must be held below  $0.87 \cdot V_{TG}$ , which is the standby threshold voltage for AT6660.

Mount a jumper to either side of 'SLOPE CTRL' to prevent AT6660 from going to standby.

The CAN transceiver is connected to the MCU through the two-pin (RX and TX) 'CAN' header near the switches on STK600. The target MCU can be any AVR device (bit banging or USART), but more typically it is one of the AT90CAN series, which support the CAN protocol in hardware.

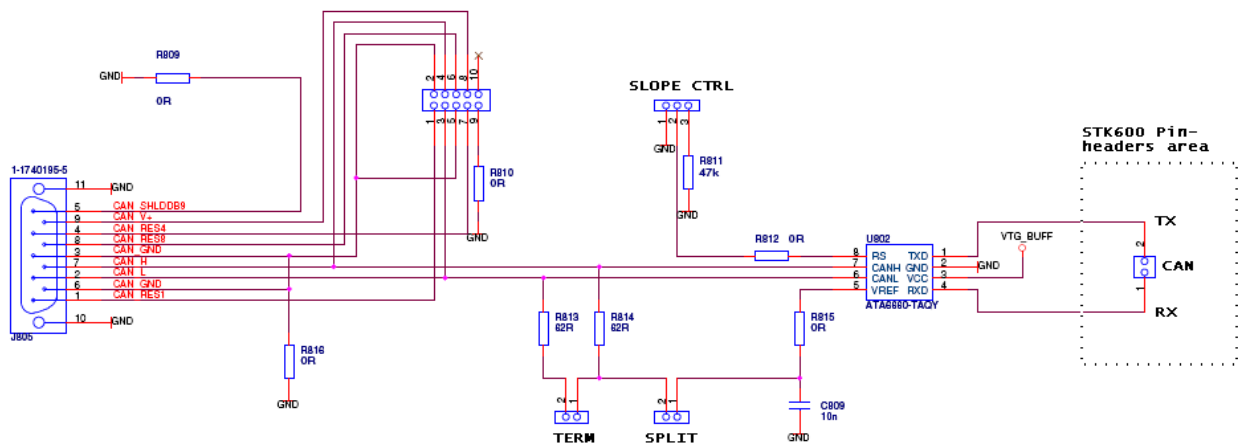

**Note:** From STK600 PCBA revision 16 the ATA6660-TAQY has been replaced with ATA6560-GAQW. These devices are pin compatible except that pin 5 of ATA6560 is NSIL (Silent mode control input, active low) and pin 8 is STBY (Standby mode control input). In other words, R815 should NOT be mounted on PCBA revision 16 or later (it is by default not mounted in production). Both NSIL and STBY are internally pulled high. The default mode is then Standby. The SLOPE CTRL header can be used to switch ATA6560 to normal mode by putting a jumper between pin 1 and 2 (pulling STBY low).



### 6.13 LIN Transceiver

Local Interconnect Network (LIN) is a broadcast serial network comprising one master and many (up to 16) slaves. The LIN bus is typically used in the automotive industry as a smaller and less expensive sub-network of a CAN bus to integrate intelligent sensor devices or actuators.

STK600 features the ATA6661 LIN transceiver. A 3-pin header serves to connect to the bus. With the ATA6661 an AVR device on the STK600 can implement a LIN master or a LIN slave.

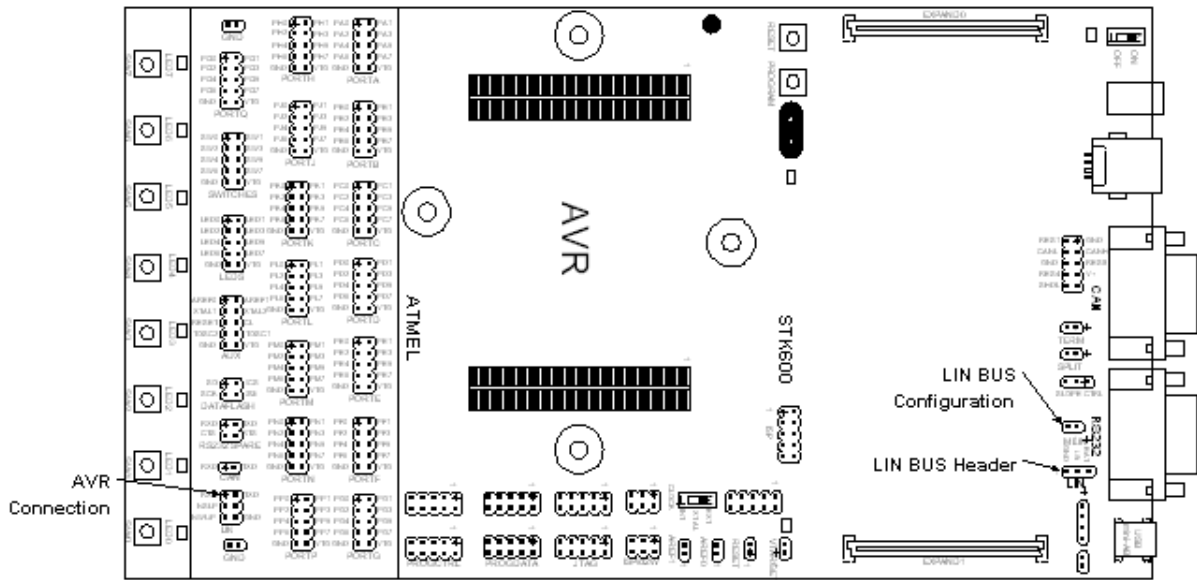

The 'M LIN' jumper provides the master node pull-up, required if the application running on STK600 is the LIN bus master.

The 3-pin LIN connector must provide V-battery ('BAT') 12V>BAT>5V, and GND. 'BAT' must be supplied from an external source. For further reference, see the ATA6661 data sheet.

The LIN transceiver is connected to the MCU through the 6-pin 'LIN' header near the switches on STK600. The target MCU will usually implement the LIN protocol in software through a USART interface. The 'NSLP' pin must be actively driven high to keep the ATA6661 from Sleep mode.

**Note:** Due to the ATA6661 design, it is mandatory to enable the internal pull-up on PD2 (RxLIN) when LIN is used (cf. AT90CAN128 Data Sheet, section "I/O Ports").

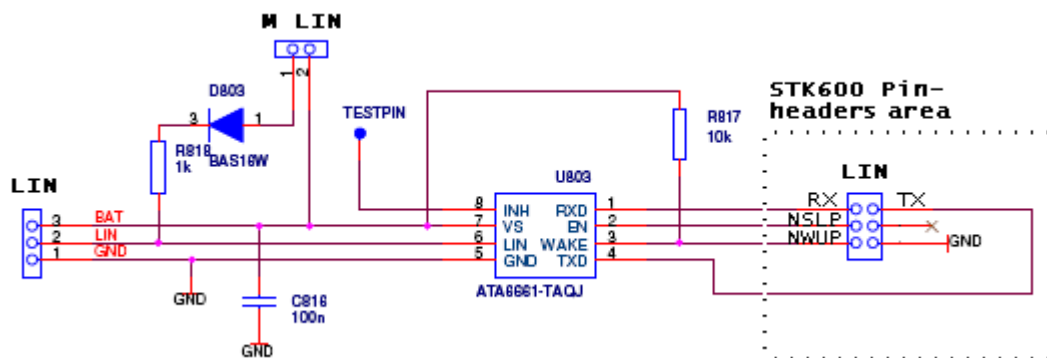

**Note:** From STK600 PCBA revision 12 the ATA6661-TAQJ was replaced by ATA6663-TAQY and from PCBA revision 16 it was replaced by ATA6663-GAQW. These three devices are all pin compatible and with the same functionality.

### 6.14 Miscellaneous

STK600 has two push buttons and three LEDs for special functions and status indication. The following sections explain these features. The figure below shows the placement of these functions.

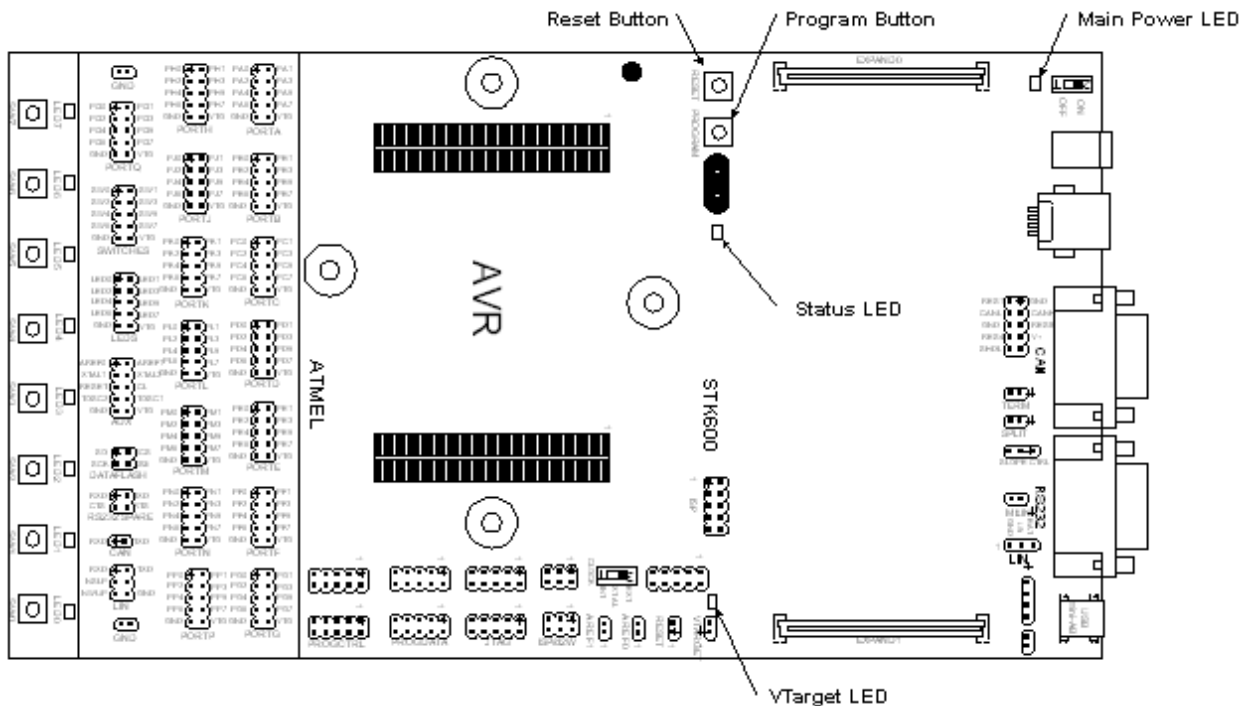

#### 6.14.1 PROGRAM Push Button

Future versions of Atmel Studio may upgrade the master MCU on STK600. Atmel Studio will then detect old software versions of STK600 and update the Flash program memory of the master MCU. To do this the user is required to push the PROGRAM button when powering on STK600. Atmel Studio issues instructions on how to perform the upgrade during the upgrade process.

#### 6.14.2 Main Power LED

The red power LED is directly connected to the STK600 main power supply. The power LED is always lit when power is applied to STK600.

#### 6.14.3 Target Power LED

The target power LED is lit when the voltage applied to the target AVR device is 0.9V or higher.

#### 6.14.4 Status LED

- ORANGE: Busy programming
- ORANGE/RED blinking: Upgrade mode
- RED: No board detected
- GREEN: READY

- ORANGE blinking: Wrong combination of routing and socket card
- RED blinking: VTarget or AREF short-circuited
- RED blinking high frequency: Too much current drawn from the power supply. If powered from USB, try to connect an external supply to the DC jack.

During programming, the LED has an orange color. When the target AVR device is successfully programmed the LED will turn green.

## 7. Programming

### 7.1 ISP Programming

In-System Programming of tinyAVR and megaAVR devices can be done using the AVR device internal SPI (Serial Peripheral Interface) to download code into the Flash and EEPROM memory. ISP programming requires only VCC, GND, RESET, and three signal lines for programming. No high-voltage signals are required. The ISP programmer can program both the internal Flash and EEPROM, fuses, lockbits, and calibration bytes.

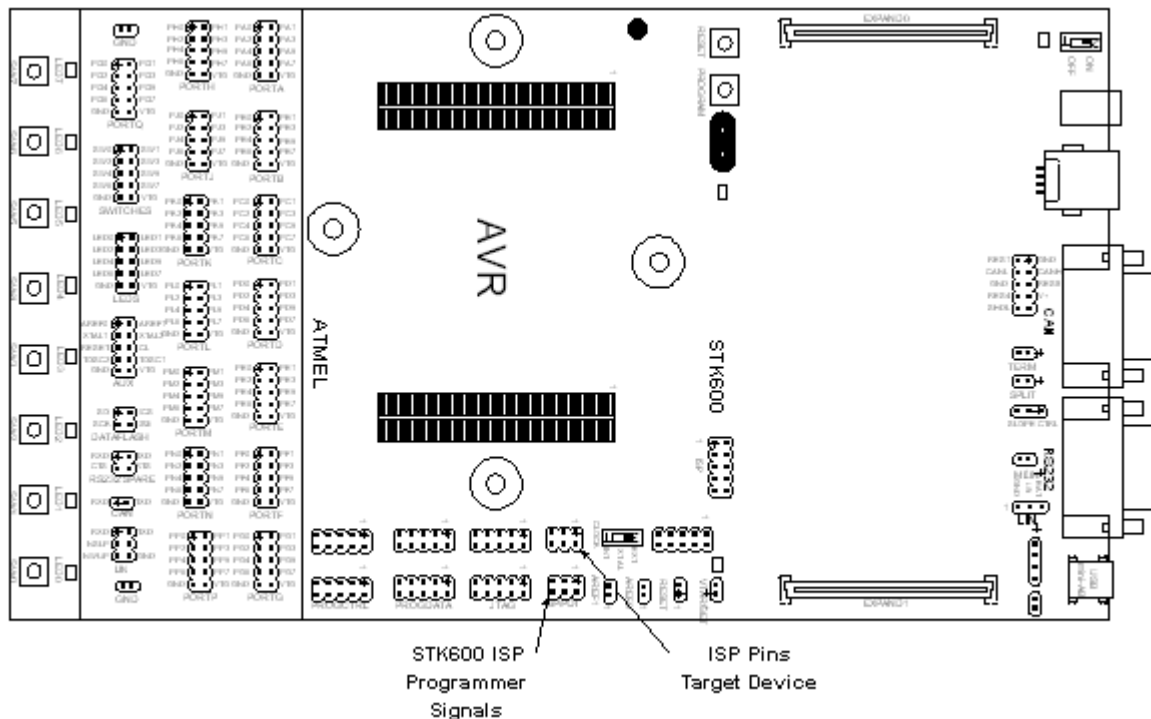

**Note:** The ISP frequency (SCK) must be less than 1/4 of the target clock. The ISP frequency is set by the STK600 programming dialog in Atmel Studio.

**Note:**

ISP programming will NOT work if one or more of the following cases are true:

- SPIEN: SPI Enable fuse is un-programmed
- RSTDISBL: Reset Disable fuse is programmed (for devices with this fuse)
- DWEN: DebugWIRE Enable fuse is programmed (for devices with this fuse)

Refer to the AVR device data sheet for information about the fuses.

Use high-voltage programming to re-enable the ISP interface from the situation listed above. Either HVPP or HVSP depending on what is supported by the AVR device.

#### 7.1.1 Hardware Setup for On-board Programming

1. Mount the routing and socket card and the target device. See the Socket System section on how to do this.
2. Connect a 6-wire cable between the two 6-pin ISP headers on the STK600. See picture below.

3. Ensure that the VTARGET jumper is mounted and that the voltage is within the operating range for the target device.

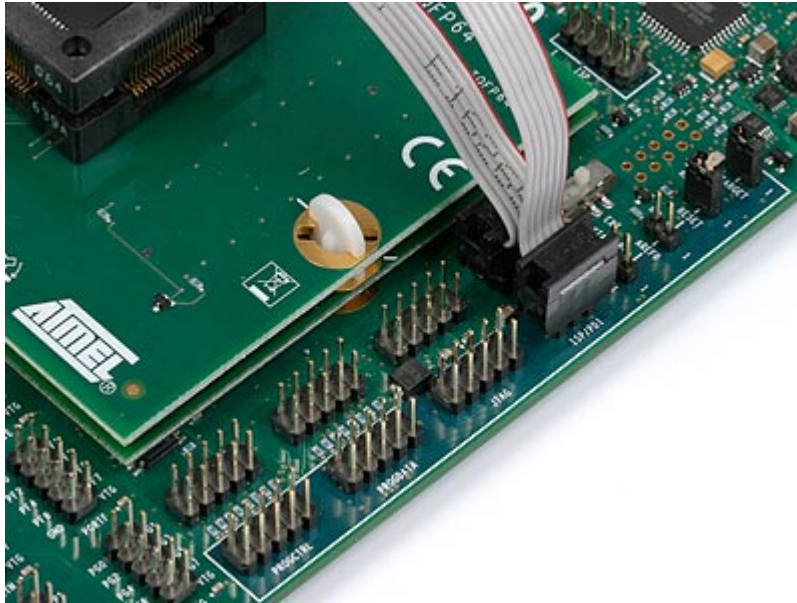

See the *Programming Dialog* pages in the Atmel Studio help file for information on the STK600 programming dialog.

The pinout of the 6- and 10-pin ISP headers are shown below:



It is not necessary to remove the ISP cable while running a program in the AVR device. The port pins used for ISP programming can be used for other purposes in the user's program.

See also: [7.9 In-System Programming of an External Target System](#).

## 7.1.2 AREF

The AREF0 jumper must be removed before programming of devices that have AREF on a pin used by the serial programming interface.

Devices that are affected by this, use these routing cards:

- STK600-RC008T-2

## 7.2 Parallel High-Voltage Programming

tinyAVR and megaAVR devices with 14 pins or more have a parallel programming interface that can be used to program all of the devices memories.

### 7.2.1 Hardware Setup for On-board Programming

Follow the steps below to do Parallel High-Voltage Programming. Note that this interface is only intended for use with on-board STK600.

1. Mount the routing and socket card and the target device. See the Socket System section on how to do this.
2. Use the two 10-wire cables supplied with the STK600 to connect the PROG DATA and the PROG CTRL to the target device, as shown in the picture below.
3. Mount both the VTARGET jumper and the RESET jumper.
4. Ensure that VTarget is between 4.5V and 5.5V.

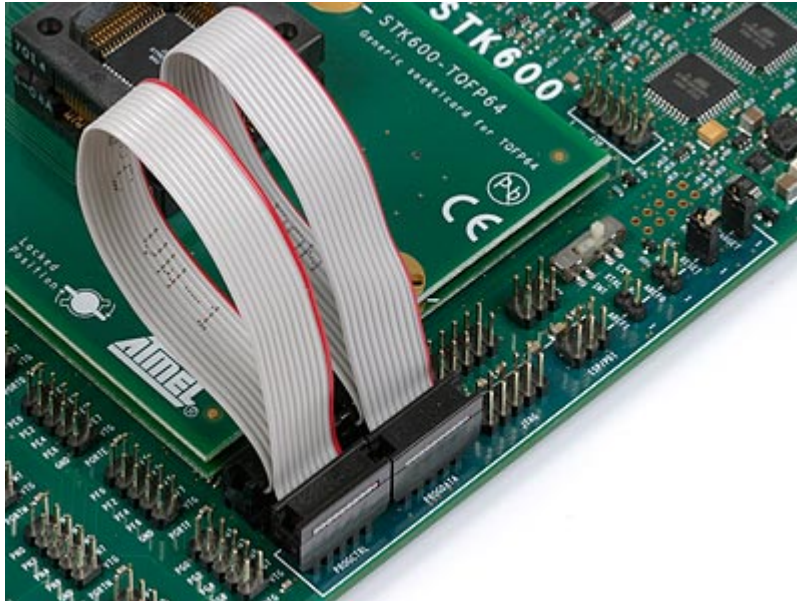

See the *Programming Dialog* pages in the Atmel Studio help file for information on the STK600 programming dialog.

**Note:** The AREF jumper must be removed before programming of devices that have AREF on a pin used by the high-voltage programming interface.

Devices that are affected by this use the following routing cards:

- STK600-RC008T-7
- STK600-RC020T-8
- STK600-RC014T-12
- STK600-RC020T-23

### 7.3 Serial High-Voltage Programming

tinyAVR devices with low pin count have too few pins to use parallel communication during high-voltage programming. They use serial communication instead. This means that fewer signals have to be routed.

**Note:** This interface is only intended for use on board the STK600.

See the device data sheet to check if a specific device has a serial high-voltage interface.

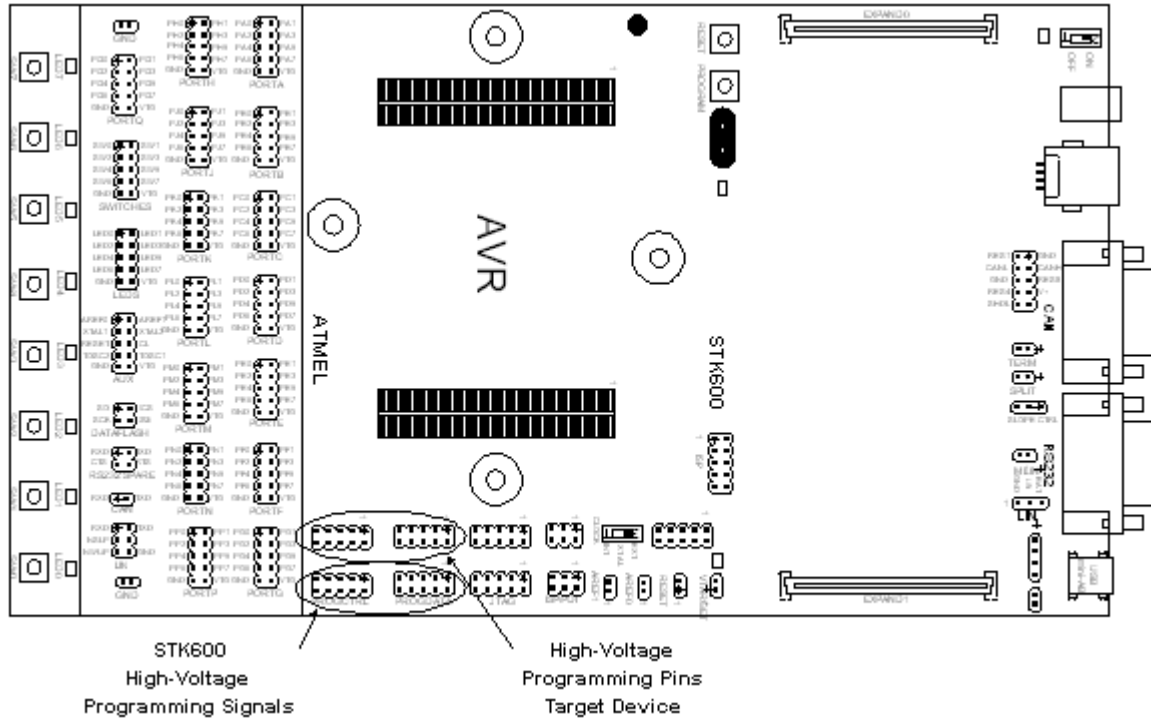

### 7.3.1 Hardware Setup for On-board Programming

1. Mount the routing and socket card, and the target device. See the Socket System section on how to do this.
2. Use a 10-wire cable supplied with the STK600 to connect the PROG DATA to the target device, as shown in the picture below.
3. Note that for ATtiny24/44/84 a cable on PROG CTRL is required as well, as for the Parallel High-Voltage Programming.
4. Mount both the VTARGET jumper and the RESET jumper.
5. Ensure that VTARGET is between 4.5 and 5.5V before programming.

See the *Programming Dialog* pages in the Atmel Studio help file for information on the STK600 programming dialog.

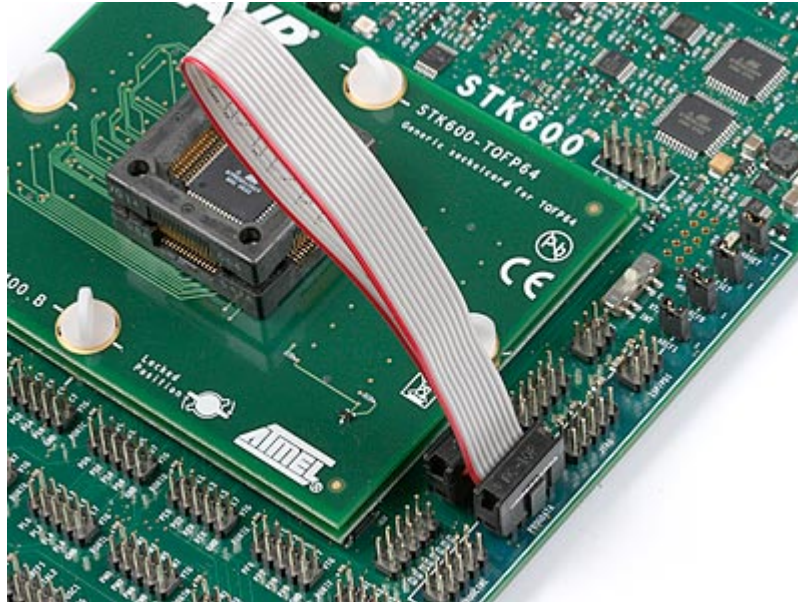

## 7.4 JTAG Programming

AVR devices with a JTAG port can be programmed through this interface.

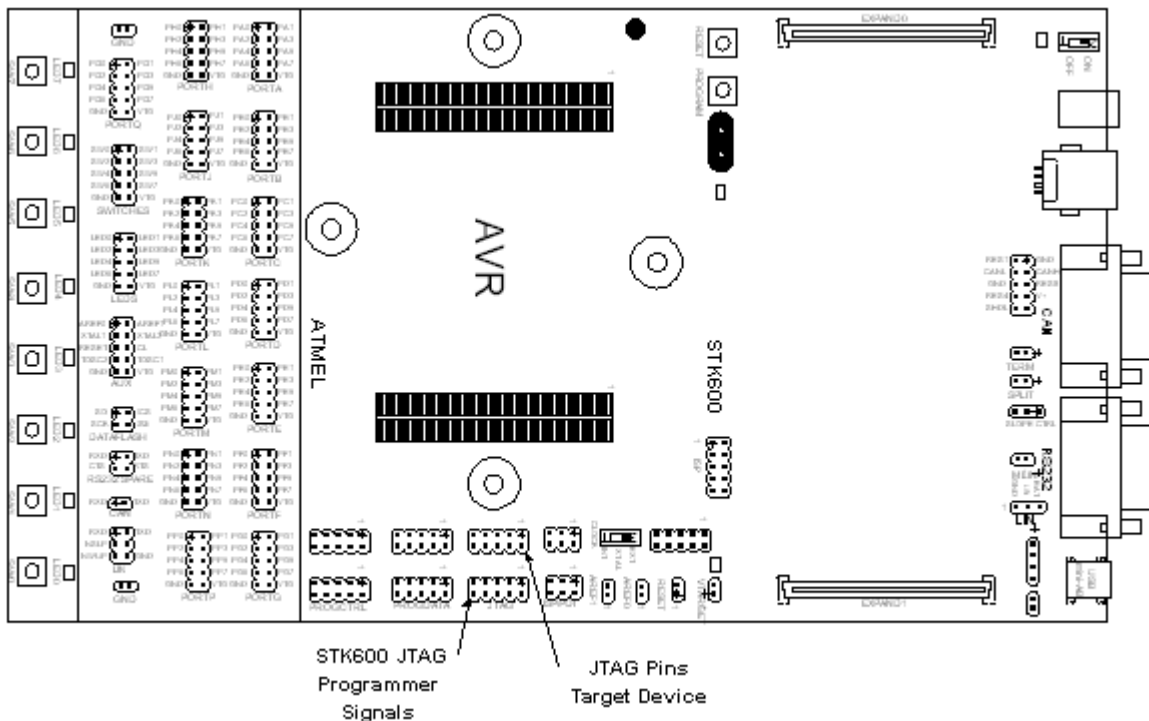

### 7.4.1 Hardware Setup for On-board Programming

1. Mount the routing and socket card, and the target device. See the Socket System section on how to do this.
2. Connect a 10-wire cable between the two 10-pin JTAG headers on the STK600. See the picture below.



3. Ensure that the VTARGET jumper is mounted and that the voltage is within the operating range for the target device.

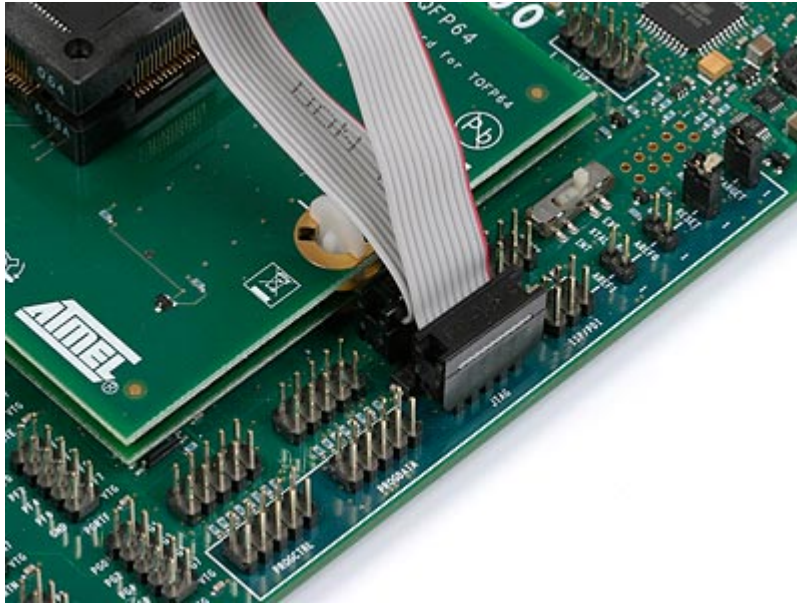

See the *Programming Dialog* pages in the Atmel Studio help file or the AVR32 Studio help for information on how to program the device using JTAG.

The pinout of the JTAG header is shown below:

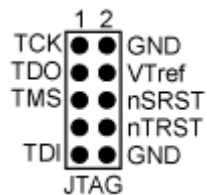

See also: [7.9 In-System Programming of an External Target System](#).

## 7.5 PDI Programming

All AVR XMEGA devices have the new PDI programming and debugging interface. It can, in-system, download code into the Flash application and boot memories, EEPROM memory, fuses, lockbits, and signature information.

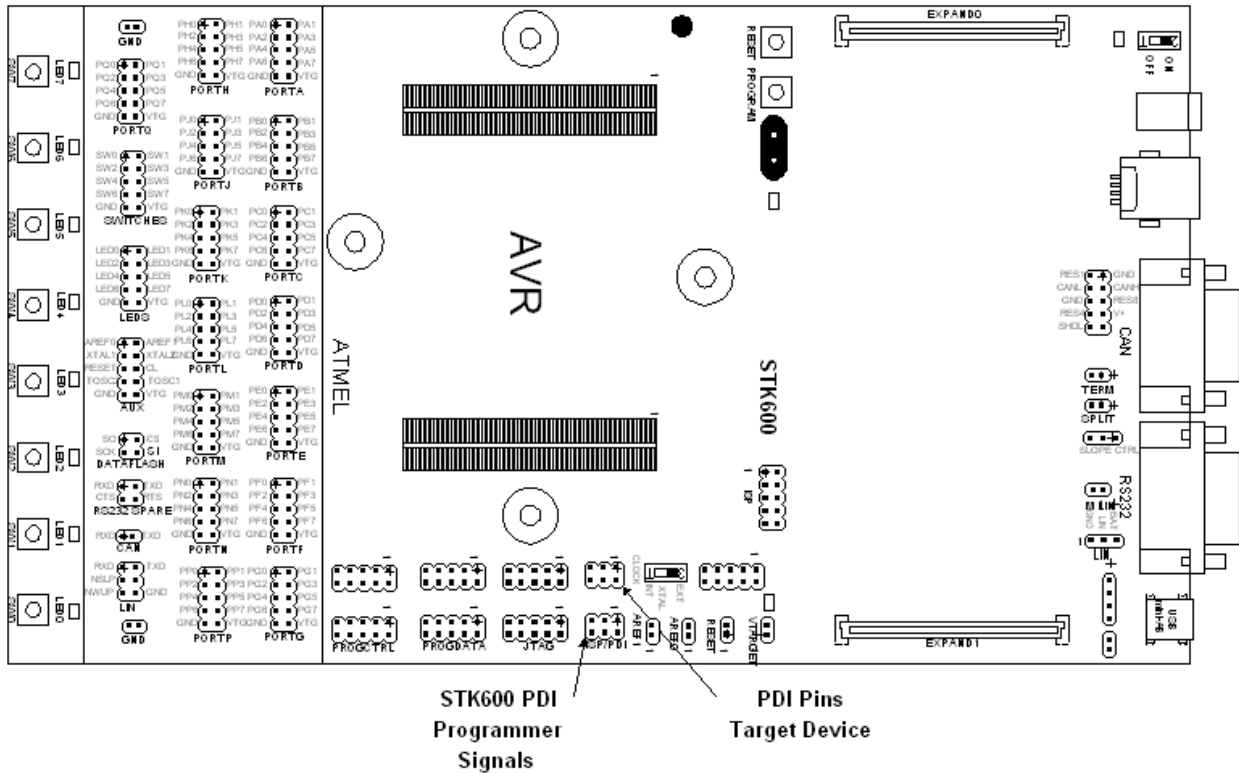

The PDI interface requires two of the device's pins; PDI\_DATA and PDI\_CLOCK. On STK600, they are found on the ISP/PDI connector.

## 7.5.1 Hardware Setup for On-board Programming

1. Mount the routing and socket card, and the target device. See the Socket System section on how to do this.
2. Connect a 6-wire cable between the two 6-pin ISP/PDI headers on the STK600. See the picture below.
3. Ensure that the VTARGET jumper is mounted and that the voltage is within the operating range for the target device.

The pinout of the 6-pin ISP/PDI header when in PDI mode is shown below:

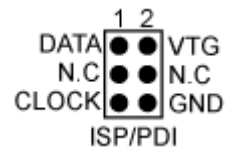
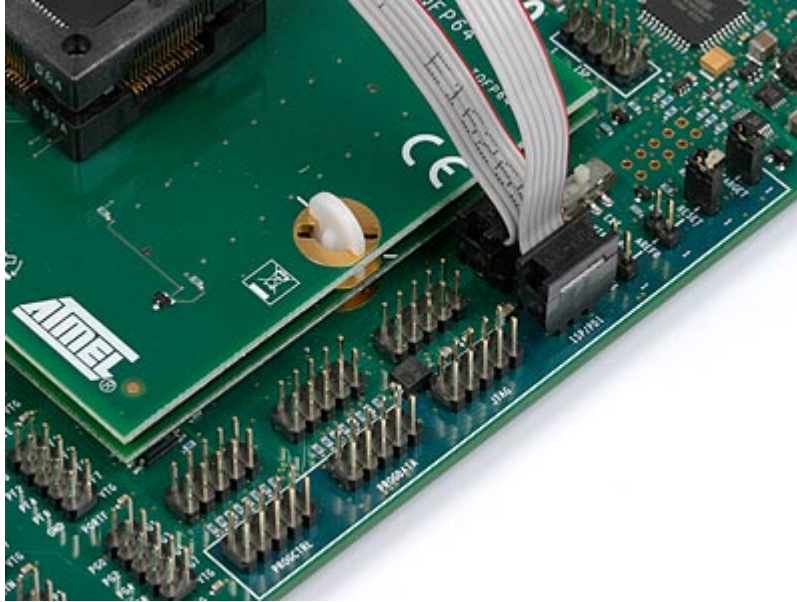

## 7.6 UPDI Programming

The Unified Program and Debug Interface (UPDI) is a proprietary interface for external programming and on-chip debugging of a device. It is a successor to the PDI 2-wire physical interface, which is found on all AVR XMEGA devices. UPDI is a single-wire interface providing a bidirectional half-duplex asynchronous communication with the target device for purposes of programming and debugging. It can, in-system, download code into the Flash application and boot memories, EEPROM memory, fuses, lockbits, and signature information.

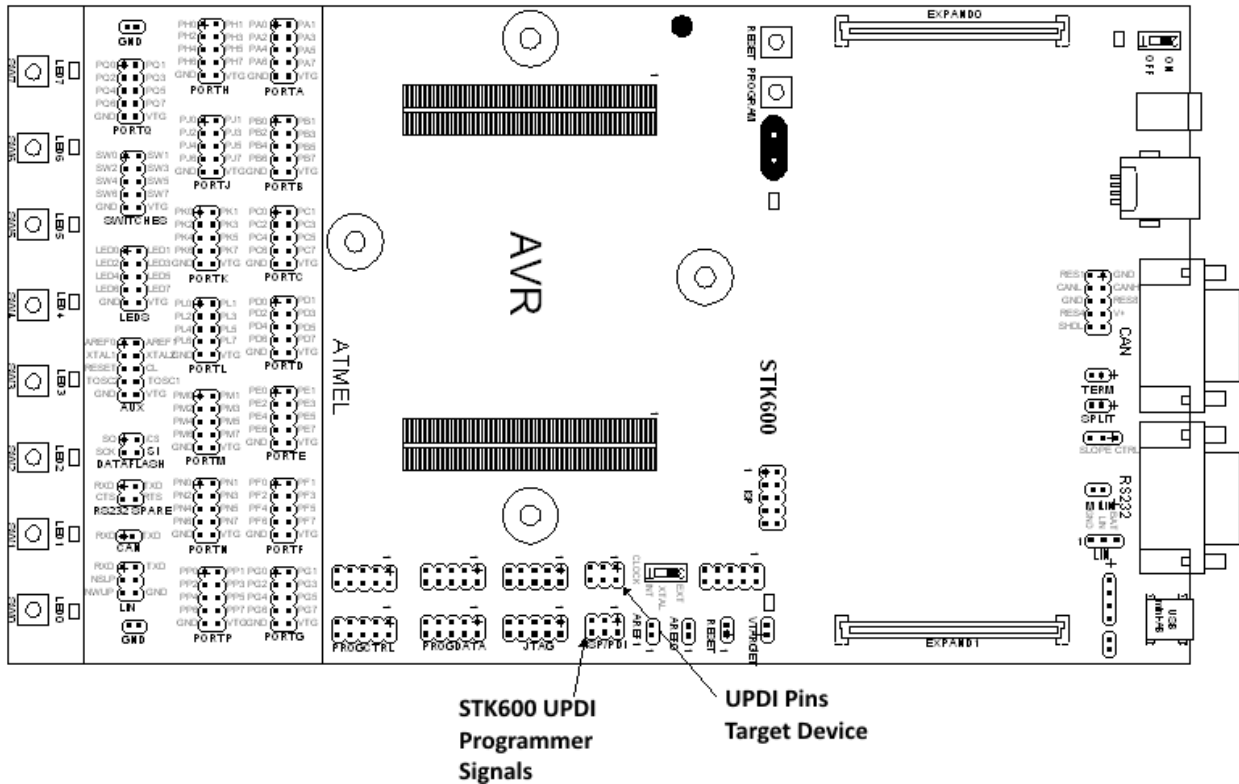

The UPDI interface requires one of the device's pins; UPDI\_DATA. On STK600, it is found on the ISP/PDI connector.

## 7.6.1 Hardware Setup for On-board Programming

1. Mount the routing and socket card, and the target device. See the Socket System section on how to do this.
2. Connect a 6-wire cable between the two 6-pin ISP/PDI headers on the STK600. See the picture below.
3. Ensure that the VTARGET jumper is mounted and that the voltage is within the operating range for the target device.



The pinout of the 6-pin ISP/PDI header when in UPDI mode is shown below:

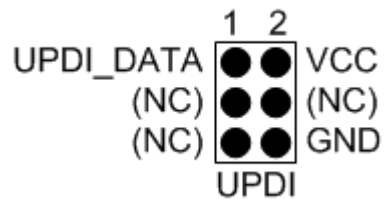

### 7.7 aWire Programming

Some AVR UC3 devices have the aWire programming and debugging interface. It can, in-system, download code into the memories.

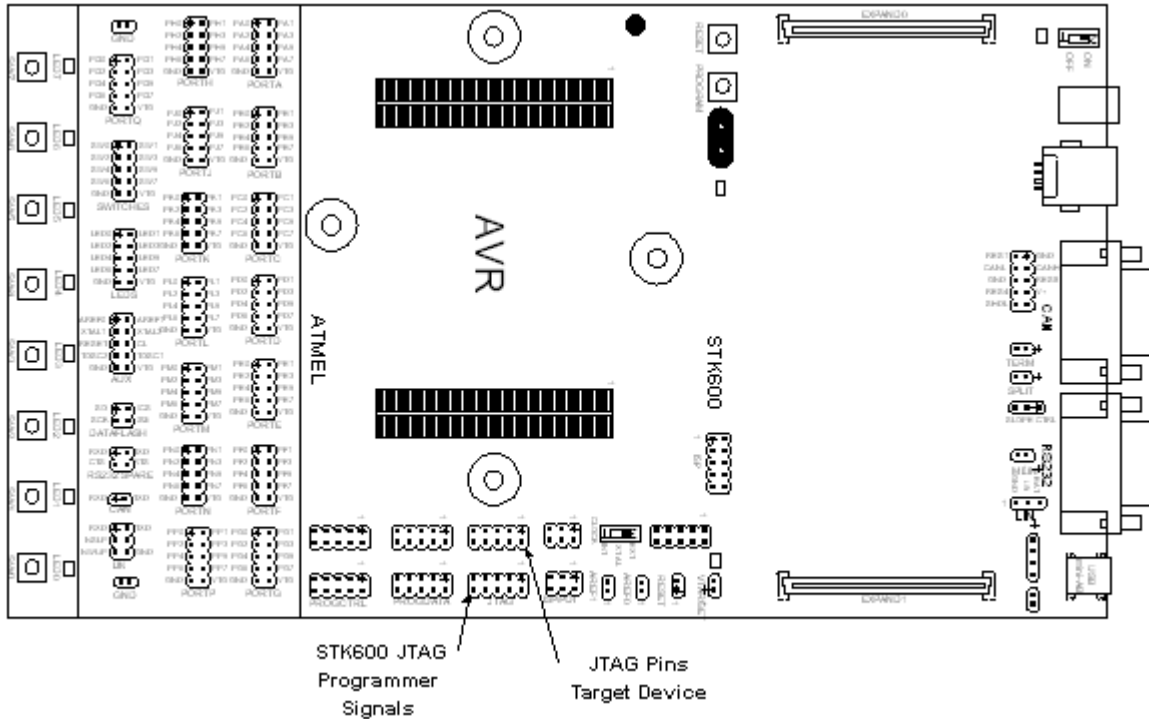

The aWire interface requires only the reset pins for serial communication. On STK600, it is found on the ISP/PDI or the JTAG connector.

### 7.7.1 Hardware Setup for aWire Programming

Connect aWire using a 6-pin cable between the ISP/PDI connectors.

For routing cards RC36 revision 3, RC38 revision 4, RC40 revision 2 and older, use the following procedure:

1. Mount the routing and socket card, and the target device. See the Socket System section on how to do this.
2. Connect a cable between Pin3 (TDO) on the JTAG header on the blue area and Pin6 (Reset) on the JTAG header on the green area. See the picture below.
3. Ensure that the VTARGET jumper is mounted and that the voltage is the within the operating range for the target device.

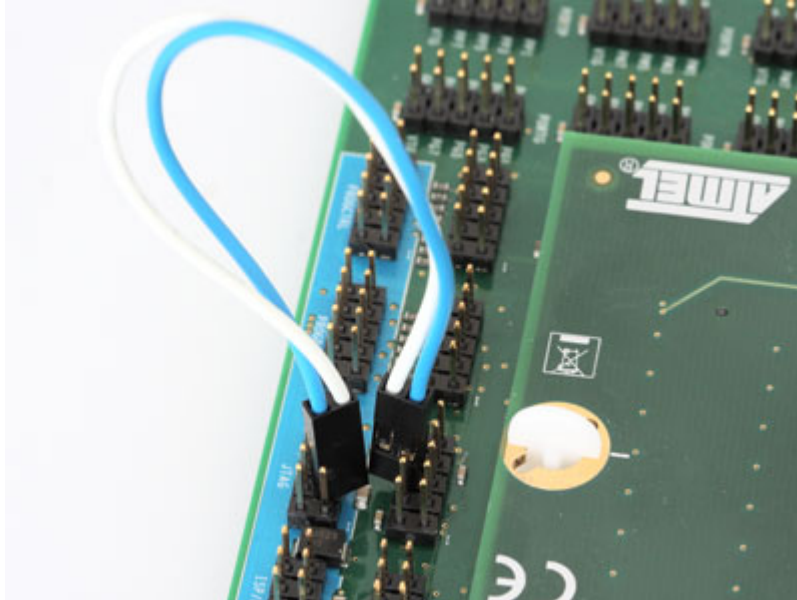

The pinout of the 10-pin JTAG header is shown below:

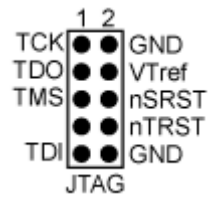

## 7.8 TPI Programming

The TPI (Tiny Programming Interface) found on some tinyAVR devices can download code into the memories of these devices.

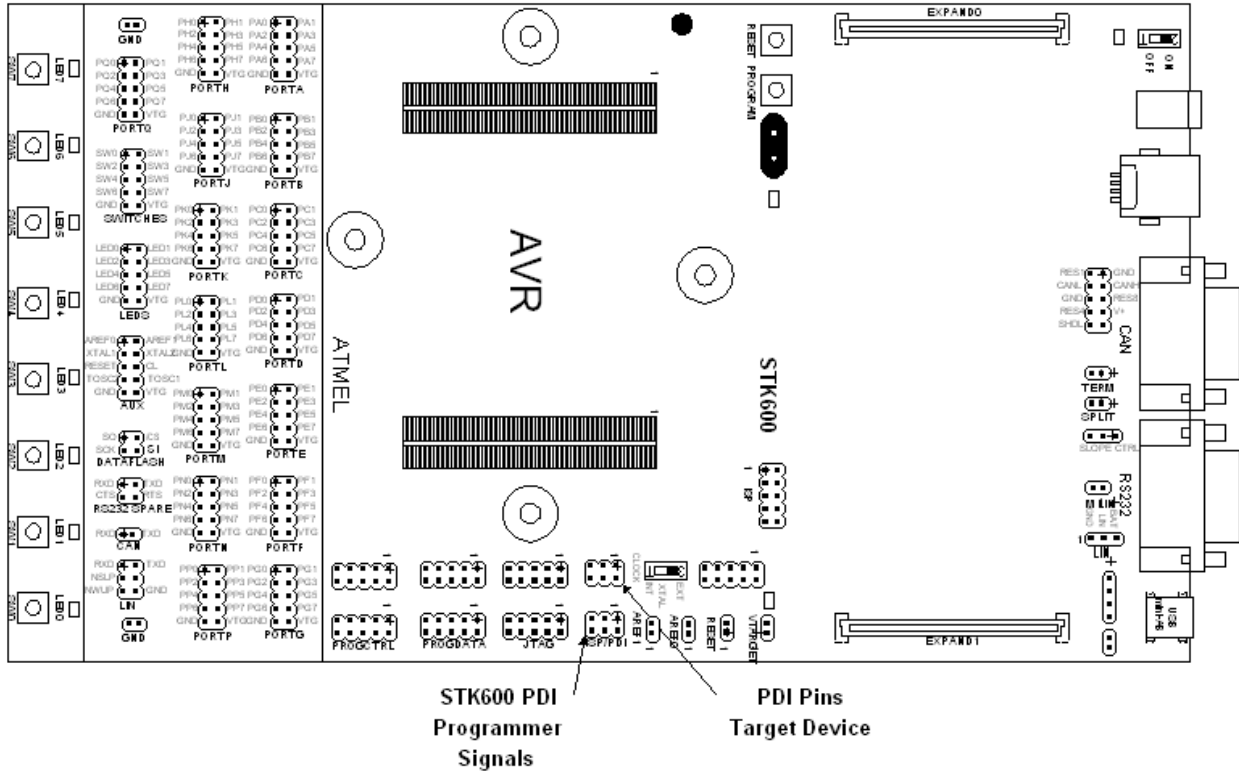

The TPI interface requires two of the device's pins; TPIDATA and TPICLK, in addition to the RESET pin. On STK600, they are found on the ISP/PDI connector.

**Note:** TPI should only be used on-board. It is not safe to program a device on an external board through the TPI interface. A 12V signal is applied to the Reset pin.

## 7.8.1 Hardware Setup for On-board Programming

1. Mount the appropriate cards and the target device. See the Socket System section on how to do this.
2. Connect a 6-wire cable between the two 6-pin ISP/PDI headers on the STK600. See the picture below.
3. Ensure that both the VTARGET and RESET jumpers are mounted.
4. Set VTARGET to 5.0V (5V is required for programming with TPI).
5. Set the clock selection switch to "INT" to disconnect the STK600 programmable clock source from TPICLK.



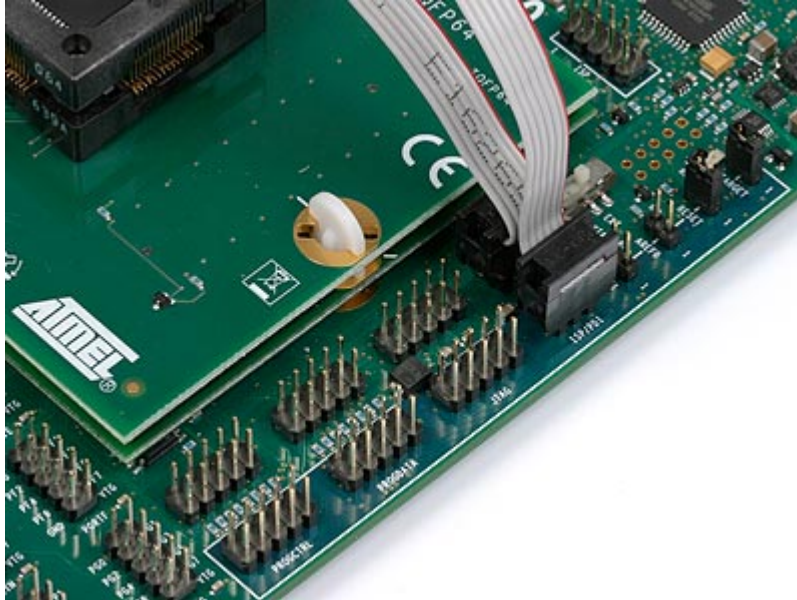

The pinout of the 6-pin ISP/PDI header when in TPI mode is shown below:

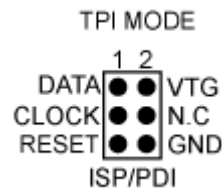

### 7.9 In-System Programming of an External Target System

The STK600 can be used as a programmer to program AVR devices in other applications. There are two different ISP connector pinouts available; a 6-pin and a 10-pin version. Both are supported by STK600. The 6-pin header is a combined ISP and PDI connector. In addition, STK600 can be used as a JTAG programmer for AVR devices with a JTAG interface.

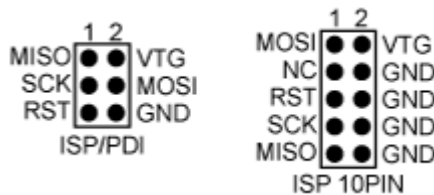

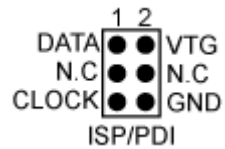
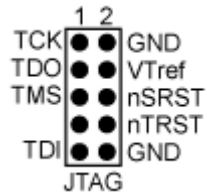

Select the device to be programmed in the same way as programming a device on STK600. The VCC of the target application is detected by STK600 and signals are converted into voltage levels suitable for the target system.

**Note:** If the other application has its own power supply, the VTARGET jumper must be removed before connecting STK600 to the other application. STK600 may be damaged if the VTARGET jumper is not removed.

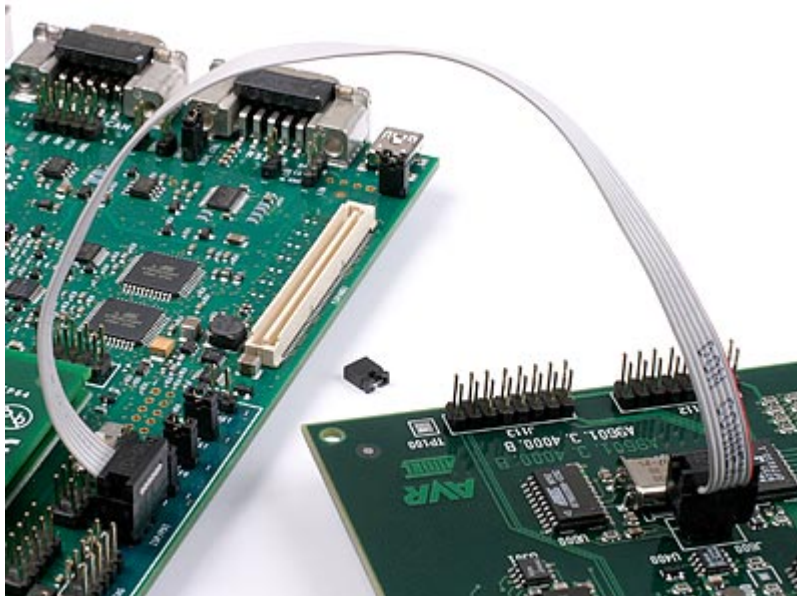

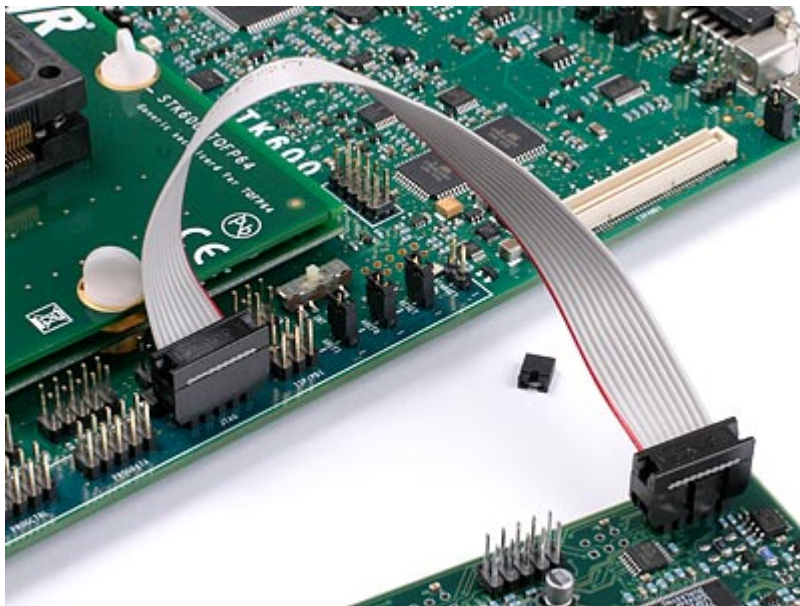
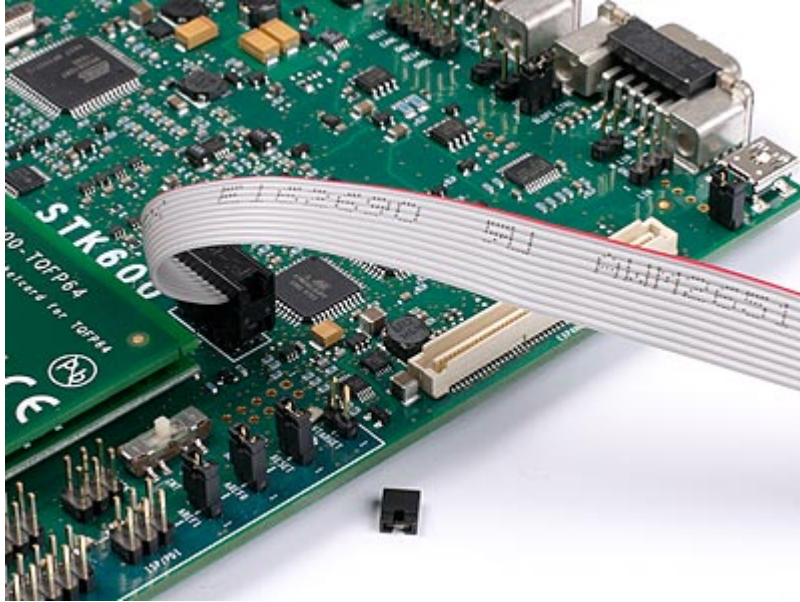

See the Programming Dialog pages in the Atmel Studio help file for information on the STK600 programming dialog.

See also the [6.2 Target Voltage VTG](#) section.

### 7.9.1 Reset Line

The reset line on any target board connected to STK600 should have a pull-up resistor. This pull-up should not be stronger than 2.2 k $\Omega$  (i.e., it should not be below 2.2 k $\Omega$ ). If the pull-up resistor on the reset line is too strong, the short circuit protection will trigger when the reset is forced low by the STK600. Any decoupling capacitor should not be larger than 10  $\mu$ F.

### 8. Command Line Utility

Atmel Studio comes with a command line utility called `atprogram` that can be used to program targets using the STK600. During the Atmel Studio installation a shortcut called “Atmel Studio 7.0. Command Prompt” was created in the Atmel folder on the Start menu. By double-clicking this shortcut, a command prompt will be opened and programming commands can be entered. The command line utility is installed in the Atmel Studio installation path in the folder `Atmel/Atmel Studio 7.0/atbackend/`.

For more help on the command line utility, type the command:

```
atprogram --help
```

## 9. Troubleshooting and Support

### 9.1 Troubleshooting Guide

Problem	Reason	Solution
The main power LED is dark	The power switch is OFF	Turn on the power switch
	No power source is connected to STK600	Do one of the following: <ul style="list-style-type: none"> <li>Connect a USB cable between STK600 and a PC. Make sure the PC is turned on.</li> <li>Connect a DC power cable to STK600. Note: The DC jack must have a center pin with positive polarity.</li> </ul>
The pre-programmed example code does not toggle the LEDs	There is no AVR device in the socket	Plug the AVR device into the right socket (see <a href="#">7.1 ISP Programming</a> and <a href="#">7.2 Parallel High-Voltage Programming</a> )
	The LEDs are not connected to the I/O ports	Connect the LEDS header to the PORTD header, and SWITCHES header to PORTB header (see <a href="#">6.6 LEDs and Switches</a> )
	No target voltage	Ensure that the VTG jumper is mounted and that VTG is set above 1.8V. VTG can be adjusted in the programming dialog of Atmel Studio.
	The Flash memory is erased	Reprogram the AVR device
The AVR device cannot be programmed using SPI	The AVR device is inserted with wrong orientation	Check that the notch on the AVR device socket matches the notch on the AVR device
	The ISP/PDI headers are not connected	Connect the 6-pin flexible cable between the two 6-pin ISP/PDI headers
	The VTARGET voltage is too low	Check the AVR device data sheet for minimum operating voltage
	The memory lock bits are programmed	Erase the memory before programming
	The SPI enable fuse is unprogrammed	Program the SPIEN fuse using <a href="#">7.2 Parallel High-Voltage Programming</a> or <a href="#">7.3 Serial High-Voltage Programming</a>
	Reset disable fuse is set	Check reset disable fuse

Problem	Reason	Solution
	SPI frequency is too high	Check STK600 SPI frequency and make sure it is lower than target clock divided by 4
	CKDIV fuse is set	Reduce ISP programming speed
	External pull-up resistor on Reset line is too low	Ensure that external pull-up resistor is $\geq 4.7$ k $\Omega$
	AREF0 jumper mounted	For some devices, the AREF0 is connected to a pin used for the ISP interface. The AREF0 jumper must, therefore, be removed to do serial programming of these devices. See the ISP Programming section for which routing cards this applies.
The AVR device cannot be programmed using JTAG	The VTARGET voltage is too low	Check the AVR device data sheet for minimum operating voltage
	The JTAG headers are not connected	Connect the 10-pin flexible cable between the two 10-pin JTAG headers. See <a href="#">7.4 JTAG Programming</a> .
	The JTAG enable fuse is unprogrammed	Program the JTAGEN fuse using <a href="#">7.2 Parallel High-Voltage Programming</a> or <a href="#">7.3 Serial High-Voltage Programming</a>
	The memory lock bits are programmed	Erase the memory before programming
The AVR device cannot be programmed using high-voltage programming	The VTARGET voltage is too low	Ensure that the voltage is at least 4.5V
	The high-voltage programming headers are not connected	Mount cables between the programming headers. See <a href="#">7.2 Parallel High-Voltage Programming</a> or <a href="#">7.3 Serial High-Voltage Programming</a>
	The reset jumper is not mounted	Mount the reset jumper
	The I/O ports are connected to peripheral circuitry (LEDs, switches, etc.)	Remove all peripheral connections from the I/O ports belonging to the high-voltage programming interface
	The memory lock bits are programmed	Erase the memory before programming
	AREF0 jumper mounted	For some devices, the AREF0 is connected to a pin used for the parallel programming interface. The AREF0 jumper must, therefore, be removed to do parallel programming of these devices.

Problem	Reason	Solution
		See the Parallel High-Voltage Programming section for which routing cards this applies.
Atmel Studio cannot connect to STK600	USB cable is not connected, or power is off	Connect USB cable
	Firmware is in a hang-up state	Toggle power on STK600
The status LED is blinking orange	Wrong combination of routing and socket card, or card removed when the kit is powered	Check the device support file for routing and socket card combination. Always turn OFF the kit power before removing or mounting routing and socket cards.
The status LED is blinking orange	The mounted cards are not recognized by STK600	The routing and socket card identification table in STK600 must be upgraded. Start Atmel Studio and connect to the kit using programming dialog. This will initiate a silent upgrade of the routing and socket card table in the STK600 controller.
The status LED is blinking red with low frequency	Short circuit on VTarget or AREF	Resolve the short circuit
The status LED is blinking red with high frequency	Too much current drawn from supply	If the kit is powered by USB, try connecting a external power to the DC jack
The status LED is steady red	Slave MCU not responding	Force STK600 into Bootloader mode, and perform a firmware upgrade
The LEDs do not work (running from external VTarget)	STK600 must be powered for LEDs to work	Supply power to STK600 and turn it ON

## 9.2 Routing and Socket Card Issues

Card Name	Revision	Issue	Work-Around
STK600-RC028M-6	A, 2	Pin PC7 on ATtinyx8 is not routed to PC7 on STK600 headers	This signal is routed to AREF0. By removing the AREF0-jumper, the signal can be used as a regular I/O.
STK600-RC100X-13	A, B, 3, 4	The USB signals for supported parts are not routed to the USB connector	The signals are routed correctly for revision 5
STK600-RCUC3C0-36	1, 2, 3	The aWire interface is not correctly routed	Connect a cable between Pin3 (TDO) on the JTAG header on the blue area and Pin6 (Reset) on the JTAG header on the green area. For external tools; connect the aWire signal pin to

Card Name	Revision	Issue	Work-Around
			Pin6 (Reset) on the JTAG header on the green area.
STK600-RCUC3C0-38	1, 2, 3, 4	The aWire interface is not correctly routed	Connect a cable between Pin3 (TDO) on the JTAG header on the blue area and Pin6 (Reset) on the JTAG header on the green area. For external tools; connect the aWire signal pin to Pin6 (Reset) on the JTAG header on the green area.
STK600-RCUC3C0-40	1, 2	The aWire interface is not correctly routed	Connect a cable between Pin3 (TDO) on the JTAG header on the blue area and Pin6 (Reset) on the JTAG header on the green area. For external tools; connect the aWire signal pin to Pin6 (Reset) on the JTAG header on the green area.

### 9.3 Technical Support

For technical support, see <http://www.microchip.com/support/hottopics.aspx>. When requesting technical support for STK600 include the following information:

- Version number of Atmel Studio. This can be found in Atmel Studio menu “Help/About”.
- PC processor type and speed
- PC operating system and version
- What target AVR device is used (complete part number)
- Programming voltage
- Jumper settings
- A detailed description of the problem

### 9.4 Firmware Upgrade

For information on how to upgrade the firmware, see the Atmel Studio user guide.

#### 9.4.1 Manual Firmware Upgrade

If an automatic firmware upgrade fails, or for some other reason connection to STK600 cannot be established, a manual firmware upgrade may solve the problem.





Before starting this procedure, make sure the latest Atmel Studio release is installed on the computer.

1. Turn off STK600 and connect it to the PC using the USB cable.
2. Press and hold the PROGRAM button when turning ON the STK600 power switch. The status LED will flash red and orange, indicating upgrade mode.
3. Run `atfw` as described in Atmel Studio user guide.
4. When complete, cycle power on STK600.
5. If the upgrade was successful, the status led will now be green. Try to connect to the starter kit with the programming tool in Atmel Studio.

## 10. Revision History

Doc Rev.	Date	Comments
C	05/2018	Updated 6.12 and 6.13 due to new part numbers for LIN and CAN transceivers. Updated Device Support section with product names in addition to order code.
B	03/2018	Updated Device Support table. Removed all references to the techlib CD-ROM/DVD.
A	08/2017	New document template. Microchip version DS40001904 Rev. A replaces Atmel version 32221 Rev. B. Updated Device Support table. Corrected some minor issues.
B	09/2016	Added UPDI interface
A	04/2016	Initial document release

## The Microchip Web Site

---

Microchip provides online support via our web site at <http://www.microchip.com/>. This web site is used as a means to make files and information easily available to customers. Accessible by using your favorite Internet browser, the web site contains the following information:

- **Product Support** – Data sheets and errata, application notes and sample programs, design resources, user's guides and hardware support documents, latest software releases and archived software
- **General Technical Support** – Frequently Asked Questions (FAQ), technical support requests, online discussion groups, Microchip consultant program member listing
- **Business of Microchip** – Product selector and ordering guides, latest Microchip press releases, listing of seminars and events, listings of Microchip sales offices, distributors and factory representatives

## Customer Change Notification Service

---

Microchip's customer notification service helps keep customers current on Microchip products. Subscribers will receive e-mail notification whenever there are changes, updates, revisions or errata related to a specified product family or development tool of interest.

To register, access the Microchip web site at <http://www.microchip.com/>. Under "Support", click on "Customer Change Notification" and follow the registration instructions.

## Customer Support

---

Users of Microchip products can receive assistance through several channels:

- Distributor or Representative
- Local Sales Office
- Field Application Engineer (FAE)
- Technical Support

Customers should contact their distributor, representative or Field Application Engineer (FAE) for support. Local sales offices are also available to help customers. A listing of sales offices and locations is included in the back of this document.

Technical support is available through the web site at: <http://www.microchip.com/support>

## Microchip Devices Code Protection Feature

---

Note the following details of the code protection feature on Microchip devices:

- Microchip products meet the specification contained in their particular Microchip Data Sheet.
- Microchip believes that its family of products is one of the most secure families of its kind on the market today, when used in the intended manner and under normal conditions.
- There are dishonest and possibly illegal methods used to breach the code protection feature. All of these methods, to our knowledge, require using the Microchip products in a manner outside the operating specifications contained in Microchip's Data Sheets. Most likely, the person doing so is engaged in theft of intellectual property.
- Microchip is willing to work with the customer who is concerned about the integrity of their code.

- Neither Microchip nor any other semiconductor manufacturer can guarantee the security of their code. Code protection does not mean that we are guaranteeing the product as “unbreakable.”

Code protection is constantly evolving. We at Microchip are committed to continuously improving the code protection features of our products. Attempts to break Microchip’s code protection feature may be a violation of the Digital Millennium Copyright Act. If such acts allow unauthorized access to your software or other copyrighted work, you may have a right to sue for relief under that Act.

## Legal Notice

---

Information contained in this publication regarding device applications and the like is provided only for your convenience and may be superseded by updates. It is your responsibility to ensure that your application meets with your specifications. MICROCHIP MAKES NO REPRESENTATIONS OR WARRANTIES OF ANY KIND WHETHER EXPRESS OR IMPLIED, WRITTEN OR ORAL, STATUTORY OR OTHERWISE, RELATED TO THE INFORMATION, INCLUDING BUT NOT LIMITED TO ITS CONDITION, QUALITY, PERFORMANCE, MERCHANTABILITY OR FITNESS FOR PURPOSE. Microchip disclaims all liability arising from this information and its use. Use of Microchip devices in life support and/or safety applications is entirely at the buyer’s risk, and the buyer agrees to defend, indemnify and hold harmless Microchip from any and all damages, claims, suits, or expenses resulting from such use. No licenses are conveyed, implicitly or otherwise, under any Microchip intellectual property rights unless otherwise stated.

## Trademarks

---

The Microchip name and logo, the Microchip logo, AnyRate, AVR, AVR logo, AVR Freaks, BeaconThings, BitCloud, CryptoMemory, CryptoRF, dsPIC, FlashFlex, flexPWR, Heldo, JukeBlox, KeeLoq, KeeLoq logo, Kleer, LANCheck, LINK MD, maXStylus, maXTouch, MediaLB, megaAVR, MOST, MOST logo, MPLAB, OptoLyzer, PIC, picoPower, PICSTART, PIC32 logo, Prochip Designer, QTouch, RightTouch, SAM-BA, SpyNIC, SST, SST Logo, SuperFlash, tinyAVR, UNI/O, and XMEGA are registered trademarks of Microchip Technology Incorporated in the U.S.A. and other countries.

ClockWorks, The Embedded Control Solutions Company, EtherSynch, Hyper Speed Control, HyperLight Load, IntelliMOS, mTouch, Precision Edge, and Quiet-Wire are registered trademarks of Microchip Technology Incorporated in the U.S.A.

Adjacent Key Suppression, AKS, Analog-for-the-Digital Age, Any Capacitor, AnyIn, AnyOut, BodyCom, chipKIT, chipKIT logo, CodeGuard, CryptoAuthentication, CryptoCompanion, CryptoController, dsPICDEM, dsPICDEM.net, Dynamic Average Matching, DAM, ECAN, EtherGREEN, In-Circuit Serial Programming, ICSP, Inter-Chip Connectivity, JitterBlocker, KleerNet, KleerNet logo, Mindi, MiWi, motorBench, MPASM, MPF, MPLAB Certified logo, MPLIB, MPLINK, MultiTRAK, NetDetach, Omniscient Code Generation, PICDEM, PICDEM.net, PICKit, PICtail, PureSilicon, QMatrix, RightTouch logo, REAL ICE, Ripple Blocker, SAM-ICE, Serial Quad I/O, SMART-I.S., SQI, SuperSwitcher, SuperSwitcher II, Total Endurance, TSHARC, USBCheck, VariSense, ViewSpan, WiperLock, Wireless DNA, and ZENA are trademarks of Microchip Technology Incorporated in the U.S.A. and other countries.

SQTP is a service mark of Microchip Technology Incorporated in the U.S.A.

Silicon Storage Technology is a registered trademark of Microchip Technology Inc. in other countries.

GestIC is a registered trademark of Microchip Technology Germany II GmbH & Co. KG, a subsidiary of Microchip Technology Inc., in other countries.

All other trademarks mentioned herein are property of their respective companies.

© 2018, Microchip Technology Incorporated, Printed in the U.S.A., All Rights Reserved.

ISBN: 978-1-5224-3055-1

## Quality Management System Certified by DNV

---

### ISO/TS 16949

Microchip received ISO/TS-16949:2009 certification for its worldwide headquarters, design and wafer fabrication facilities in Chandler and Tempe, Arizona; Gresham, Oregon and design centers in California and India. The Company's quality system processes and procedures are for its PIC<sup>®</sup> MCUs and dsPIC<sup>®</sup> DSCs, KEELOQ<sup>®</sup> code hopping devices, Serial EEPROMs, microperipherals, nonvolatile memory and analog products. In addition, Microchip's quality system for the design and manufacture of development systems is ISO 9001:2000 certified.

## Worldwide Sales and Service

AMERICAS	ASIA/PACIFIC	ASIA/PACIFIC	EUROPE
<p><b>Corporate Office</b> 2355 West Chandler Blvd. Chandler, AZ 85224-6199 Tel: 480-792-7200 Fax: 480-792-7277 Technical Support: <a href="http://www.microchip.com/support">http://www.microchip.com/support</a> Web Address: <a href="http://www.microchip.com">www.microchip.com</a></p> <p><b>Atlanta</b> Duluth, GA Tel: 678-957-9614 Fax: 678-957-1455</p> <p><b>Austin, TX</b> Tel: 512-257-3370</p> <p><b>Boston</b> Westborough, MA Tel: 774-760-0087 Fax: 774-760-0088</p> <p><b>Chicago</b> Itasca, IL Tel: 630-285-0071 Fax: 630-285-0075</p> <p><b>Dallas</b> Addison, TX Tel: 972-818-7423 Fax: 972-818-2924</p> <p><b>Detroit</b> Novi, MI Tel: 248-848-4000</p> <p><b>Houston, TX</b> Tel: 281-894-5983</p> <p><b>Indianapolis</b> Noblesville, IN Tel: 317-773-8323 Fax: 317-773-5453 Tel: 317-536-2380</p> <p><b>Los Angeles</b> Mission Viejo, CA Tel: 949-462-9523 Fax: 949-462-9608 Tel: 951-273-7800</p> <p><b>Raleigh, NC</b> Tel: 919-844-7510</p> <p><b>New York, NY</b> Tel: 631-435-6000</p> <p><b>San Jose, CA</b> Tel: 408-735-9110 Tel: 408-436-4270</p> <p><b>Canada - Toronto</b> Tel: 905-695-1980 Fax: 905-695-2078</p>	<p><b>Australia - Sydney</b> Tel: 61-2-9868-6733</p> <p><b>China - Beijing</b> Tel: 86-10-8569-7000</p> <p><b>China - Chengdu</b> Tel: 86-28-8665-5511</p> <p><b>China - Chongqing</b> Tel: 86-23-8980-9588</p> <p><b>China - Dongguan</b> Tel: 86-769-8702-9880</p> <p><b>China - Guangzhou</b> Tel: 86-20-8755-8029</p> <p><b>China - Hangzhou</b> Tel: 86-571-8792-8115</p> <p><b>China - Hong Kong SAR</b> Tel: 852-2943-5100</p> <p><b>China - Nanjing</b> Tel: 86-25-8473-2460</p> <p><b>China - Qingdao</b> Tel: 86-532-8502-7355</p> <p><b>China - Shanghai</b> Tel: 86-21-3326-8000</p> <p><b>China - Shenyang</b> Tel: 86-24-2334-2829</p> <p><b>China - Shenzhen</b> Tel: 86-755-8864-2200</p> <p><b>China - Suzhou</b> Tel: 86-186-6233-1526</p> <p><b>China - Wuhan</b> Tel: 86-27-5980-5300</p> <p><b>China - Xian</b> Tel: 86-29-8833-7252</p> <p><b>China - Xiamen</b> Tel: 86-592-2388138</p> <p><b>China - Zhuhai</b> Tel: 86-756-3210040</p>	<p><b>India - Bangalore</b> Tel: 91-80-3090-4444</p> <p><b>India - New Delhi</b> Tel: 91-11-4160-8631</p> <p><b>India - Pune</b> Tel: 91-20-4121-0141</p> <p><b>Japan - Osaka</b> Tel: 81-6-6152-7160</p> <p><b>Japan - Tokyo</b> Tel: 81-3-6880-3770</p> <p><b>Korea - Daegu</b> Tel: 82-53-744-4301</p> <p><b>Korea - Seoul</b> Tel: 82-2-554-7200</p> <p><b>Malaysia - Kuala Lumpur</b> Tel: 60-3-7651-7906</p> <p><b>Malaysia - Penang</b> Tel: 60-4-227-8870</p> <p><b>Philippines - Manila</b> Tel: 63-2-634-9065</p> <p><b>Singapore</b> Tel: 65-6334-8870</p> <p><b>Taiwan - Hsin Chu</b> Tel: 886-3-577-8366</p> <p><b>Taiwan - Kaohsiung</b> Tel: 886-7-213-7830</p> <p><b>Taiwan - Taipei</b> Tel: 886-2-2508-8600</p> <p><b>Thailand - Bangkok</b> Tel: 66-2-694-1351</p> <p><b>Vietnam - Ho Chi Minh</b> Tel: 84-28-5448-2100</p>	<p><b>Austria - Wels</b> Tel: 43-7242-2244-39 Fax: 43-7242-2244-393</p> <p><b>Denmark - Copenhagen</b> Tel: 45-4450-2828 Fax: 45-4485-2829</p> <p><b>Finland - Espoo</b> Tel: 358-9-4520-820</p> <p><b>France - Paris</b> Tel: 33-1-69-53-63-20 Fax: 33-1-69-30-90-79</p> <p><b>Germany - Garching</b> Tel: 49-8931-9700</p> <p><b>Germany - Haan</b> Tel: 49-2129-3766400</p> <p><b>Germany - Heilbronn</b> Tel: 49-7131-67-3636</p> <p><b>Germany - Karlsruhe</b> Tel: 49-721-625370</p> <p><b>Germany - Munich</b> Tel: 49-89-627-144-0 Fax: 49-89-627-144-44</p> <p><b>Germany - Rosenheim</b> Tel: 49-8031-354-560</p> <p><b>Israel - Ra'anana</b> Tel: 972-9-744-7705</p> <p><b>Italy - Milan</b> Tel: 39-0331-742611 Fax: 39-0331-466781</p> <p><b>Italy - Padova</b> Tel: 39-049-7625286</p> <p><b>Netherlands - Drunen</b> Tel: 31-416-690399 Fax: 31-416-690340</p> <p><b>Norway - Trondheim</b> Tel: 47-7289-7561</p> <p><b>Poland - Warsaw</b> Tel: 48-22-3325737</p> <p><b>Romania - Bucharest</b> Tel: 40-21-407-87-50</p> <p><b>Spain - Madrid</b> Tel: 34-91-708-08-90 Fax: 34-91-708-08-91</p> <p><b>Sweden - Gothenberg</b> Tel: 46-31-704-60-40</p> <p><b>Sweden - Stockholm</b> Tel: 46-8-5090-4654</p> <p><b>UK - Wokingham</b> Tel: 44-118-921-5800 Fax: 44-118-921-5820</p>